

Технические характеристики

По вопросам продаж и поддержки обращайтесь:

Алматы (7273)495-231
Ангарск (3955)60-70-56
Архангельск (8182)63-90-72
Астрахань (8512)99-46-04
Барнаул (3852)73-04-60
Белгород (4722)40-23-64
Благовещенск (4162)22-76-07
Брянск (4832)59-03-52
Владивосток (423)249-28-31
Владикавказ (8672)28-90-48
Владимир (4922)49-43-18
Волгоград (844)278-03-48
Вологда (8172)26-41-59
Воронеж (473)204-51-73
Екатеринбург (343)384-55-89
Иваново (4932)77-34-06
Ижевск (3412)26-03-58
Иркутск (395)279-98-46
Казань (843)206-01-48
Россия +7(495)268-04-70

Калининград (4012)72-03-81
Калуга (4842)92-23-67
Кемерово (3842)65-04-62
Киров (8332)68-02-04
Коломна (4966)23-41-49
Кострома (4942)77-07-48
Краснодар (861)203-40-90
Красноярск (391)204-63-61
Курск (4712)77-13-04
Липецк (4742)52-20-81
Магнитогорск (3519)55-03-13
Москва (495)268-04-70
Мурманск (8152)59-64-93
Набережные Челны (8552)20-53-41
Нижний Новгород (831)429-08-12
Новокузнецк (3843)20-46-81
Ноябрьск (3496)41-32-12
Новосибирск (383)227-86-73
Киргизия +996(312)-96-26-47

Омск (3812)21-46-40
Орел (4862)44-53-42
Оренбург (3532)37-68-04
Пенза (8412)22-31-16
Петрозаводск (8142)55-98-37
Псков (8112)59-10-37
Пермь (342)205-81-47
Ростов-на-Дону (863)308-18-15
Рязань (4912)46-61-64
Самара (846)206-03-16
Саранск (8342)22-96-24
Санкт-Петербург (812)309-46-40
Саратов (845)249-38-78
Севастополь (8692)22-31-93
Симферополь (3652)67-13-56
Смоленск (4812)29-41-54
Сочи (862)225-72-31
Ставрополь (8652)20-65-13
Сургут (3462)77-98-35
Казахстан +7(7172)727-132

Сыктывкар (8212)25-95-17
Тамбов (4752)50-40-97
Тверь (4822)63-31-35
Тольятти (8482)63-91-07
Томск (3822)98-41-53
Тула (4872)33-79-87
Тюмень (3452)66-21-18
Ульяновск (8422)24-23-59
Улан-Удэ (3012)59-97-51
Уфа (347)229-48-12
Хабаровск (4212)92-98-04
Чебоксары (8352)28-53-07
Челябинск (351)202-03-61
Череповец (8202)49-02-64
Чита (3022)38-34-83
Якутск (4112)23-90-97
Ярославль (4852)69-52-93



C110100

EN Foldable bed

Epoxy coated steel frame, steel wire mesh mattress platform.
Adjustable backrest 45° by means of a rack device.
Dimensions: 65 x 190 x 50cm Capacity: 150Kg

FR Lit médical pliant

Structure en acier laqué époxy.
Sommier en treillis métallique.
Relève-buste réglable par crémaillère à 45°
Dimensions: 65 x 190 x 50cm Capacité: 150Kg

IT Letto pieghevole

Struttura in acciaio verniciato.
Piano rete in maglia rigida
Schienale regolabile a 45° tramite cremagliera.
Dimensioni: 65 x 190 x 50cm Capacità: 150 kg



C110103

EN Dismountable hospital bed

Frame made of epoxy coated steel tube
Bed ends with horizontal bars
Platform with epoxy-painted steel weldmesh
Dimensions: 85 x 195 x 52 cm. Capacity: 150Kg

FR Lit d'hôpital démontable

Cadre en tube d'acier revêtement époxy
Tête et pied de lit à barreaux horizontaux
Sommier en treillis métallique, revêtement époxy
Dimensions: 85 x 195 x 52 cm. Capacité: 150Kg

IT Letto ospedaliero smontabile

Telaio in tubo d'acciaio verniciato
Testate con barre orizzontali verniciate
Piano rete in maglia rigida
Dimensioni: 85 x 195 x 52 cm. Capacità: 150 kg



C110104

EN Dismountable hospital bed

Frame made of epoxy coated steel tube
Platform with epoxy-painted steel weldmesh
Adjustable backrest 45° by means of a rack device
Dimensions: 85 x 195 x 52 cm. Capacity: 150Kg

FR Lit d'hôpital démontable

Structure en acier laqué époxy
Sommier en treillis métallique
Relève-buste réglable par crémaillère à 45°
Dimensions: 85 x 195 x 52 cm. Capacité: 150Kg

IT Letto ospedaliero smontabile

Struttura in acciaio verniciato
Piano rete in maglia rigida
Schienale regolabile a 45° tramite cremagliera
Dimensioni: 85 x 195 x 52 cm. Capacità: 150 kg



C110090



C110091



C110092



C110094



C110106



C110121

EN Hospital bed

Epoxy coated bed ends with vertical bars

Mattress platform made of epoxy coated steel with rigid mesh

4 castors ø100 mm, 2 with brakes

C110090 Bed without backrest

C110091 Backrest adjustable by rack

C110092 Backrest adjustable by rack and castors

C110094 With castors

C110106 Backrest adjustable by crank and castors

C110121 Backrest, footrest adjustable by crank and castors

Dimensions: 85 x 200 x 50cm. Capacity: 150Kg

FR Lit hospitalier

Tête et pied de lit à barreaux verticaux revêtement époxy

Bâti métallique, revêtement époxy. Sommier en treillis métallique 4

roues ø100 mm, 2 avec frein

C110090 Lit sans relève-buste

C110091 Relève-buste réglable par crémaillère

C110092 Relève-buste réglable par crémaillère et roues

C110094 Avec roues

C110106 Relève-buste réglables par manivelle et roues

C110121 Relève-buste, relève-jambe réglables par manivelle et roues

Dimensions: 85 x 200 x 50cm. Capacité: 150Kg

IT Letti ospedalieri

Testate con rivestimento epossidico a barre verticali

Struttura in acciaio, rivestimento epossidico. Piano rete in maglia

rigida. Fornito con 4 ruote ø100 mm, 2 con freno

C110090 Letto senza alzatesta

C110091 Alzatesta regolabile con cremagliera

C110092 Alzatesta regolabile con cremagliera fornito con ruote

C110094 Con ruote

C110106 Alzatesta regolabile con manovella fornito con ruote

C110121 Alzatesta poggia gambe regolabili con manovelle con ruote

Dimensions: 85 x 200 x 50cm. Capacità: 150Kg



C110098



C110097



C110096



C110095



EN Hospital bed

Chrome-plated steel bed ends with laminated plastic panels
 Mattress platform made of epoxy coated steel with rigid mesh
 4 castors ø100 mm, 2 with brakes

C110095 Backrest adjustable by rack and castors

C110096 Backrest adjustable by rack

C110097 With castors

C110098 Bed without backrest

C110105 Backrest adjustable by crank and castors

C110120 Backrest, footrest adjustable by crank and castors

Dimensions: 85 x 200 x 50cm. Capacity: 150Kg

FR Lit hospitalier

Tête et pied en acier chromé avec panneaux laminés
 Bâti métallique, revêtement époxy. Sommier en treillis métallique 4
 roues ø100 mm, 2 avec frein

C110095 Relève-buste réglable par crémaillère et roues

C110096 Relève-buste réglable par crémaillère

C110097 Avec roues

C110098 Lit sans relève-buste

C110105 Relève-buste réglables par manivelle et roues

C110120 Relève-buste, relève-jambe réglables par manivelle et roues

Dimensions: 85 x 200 x 50cm. Capacité: 150Kg

IT Letti ospedalieri

Testate in acciaio cromato con pannelli in laminato plastico
 Struttura in acciaio, rivestimento epossidico. Piano rete in maglia
 rigida. Fornito con 4 ruote ø100 mm, 2 con freno

C110095 Alzatesta regolabile con cremagliera fornito con ruote

C110096 Alzatesta regolabile con cremagliera

C110097 Con ruote

C110098 Letto senza alzatesta

C110105 Alzatesta regolabile con manovella fornito con ruote

C110120 Alzatesta poggia gambe regolabili con manovelle con ruote

Dimensions: 85 x 200 x 50cm. Capacità: 150Kg



C110105



C110120





ON REQUEST / SUR DEMANDE / A RICHIESTA
Collapsible side rails / Barrières de lit / Spondine laterali

01.100.00



01.101.00



01.102.00



01.101.00

EN Hospital bed

Frame made of epoxy painted steel tube.
Backrest adjustable by crank.
Stainless steel tube removable bed ends with laminated plastic panels.
Platform fitted with weldmesh.
4 castors ø125 mm, 2 w/brakes.
Bumpers at all four corners.
Dimensions: 92 x 205 x 50 cm.
Capacity: 150Kg

FR Lit hospitalier

Cadre en tube d'acier epoxy.
Relève-buste réglables par manivelle.
Tube amovibles en acier inox avec tête et pied de lit à panneaux laminés.
Sommier en treillis métallique soudé.
4 roues ø125 mm, 2 avec frein.
Galets pare-chocs aux coins.
Dimensions: 92 x 205 x 50 cm
Capacité: 150Kg

IT Letto ospedaliero

Struttura in acciaio verniciato.
Alzatesta regolabile tramite manovella.
Testate estraibili in tubo di acciaio inox con pannelli in laminato plastico.
Piano rete in maglia rigida.
4 ruote ø125 mm, 2 con freni.
Paracolpi in tutti e quattro gli angoli.
Dimensioni: 92 x 205 x 50 cm.
Capacità: 150Kg



01.300.00



01.301.00



01.302.00



01.300.00

EN Hospital bed

Frame made of epoxy painted steel tube.
Backrest and leg section adjustable by cranks.
Stainless steel tube removable bed ends with laminated plastic panels.
Platform fitted with weldmesh.
4 castors ø125 mm, 2 w/brakes.
Bumpers at all four corners.
Dimensions: 92 x 205 x 50 cm.
Capacity: 150Kg

FR Lit hospitalier

Cadre en tube d'acier epoxy. Relève-buste et relève-jambes réglables par manivelles.
Tube amovibles en acier inox avec tête et pied de lit à panneaux laminés.
Sommier en treillis métallique soudé.
4 roues ø125 mm, 2 avec frein.
Galets pare-chocs aux coins.
Dimensions: 92 x 205 x 50 cm
Capacité: 150Kg

IT Letto ospedaliero

Struttura in acciaio verniciato. Alzatesta e poggia gambe regolabili tramite manovella.
Testate estraibili in tubo di acciaio inox con pannelli in laminato plastico.
Piano rete in maglia rigida.
4 ruote ø125 mm, 2 con freni.
Paracolpi in tutti e quattro gli angoli.
Dimensioni: 92 x 205 x 50 cm.
Capacità: 150Kg



01.300.TRG

EN Bed with Trendelenburg

Frame made of epoxy painted steel tube. Backrest and leg section adjustable by cranks. Trendelenburg (10°) and reverse Trendelenburg (15°) adjustable by gas pump. S.S. tube removable bed ends with laminated plastic panels. Platform fitted with weldmesh. 4 castors ø125 mm, 2 w/brakes. Bumpers at all four corners. Dimensions: 92 x 205 x 50 cm. Capacity: 150Kg

FR Lit avec Trendelenburg

Cadre en tube d'acier epoxy. Relève-buste et relève-jambes réglables par manivelles. Positions Trendelenburg (10°) et reverse Trendelenburg (15°) réglables par pompes à gaz. Tube amovible en acier inox avec tête et pied de lit à panneaux laminés. Sommier en treillis métallique soudé. 4 roues, ø125 mm 2 avec frein. Galets pare-chocs aux coins. Dimensions: 92 x 205 x 50 cm. Capacité: 150Kg

IT Letto con Trendelenburg

Struttura in acciaio verniciato. Alzatesta e poggia gambe regolabili tramite manovelle. Trendelenburg (10°) e anti Trendelenburg (15°) regolabili tramite pompa a gas. Testate estraibili in tubo di acciaio inox con pannelli in laminato plastico. Piano rete in maglia rigida. 4 ruote ø125 mm, 2 con freni. Paracolpi in tutti e quattro gli angoli. Dimensioni: 92 x 205 x 50 cm. Capacità: 150Kg

01.300.TRG



01.301.TRG



01.302.TRG



01.300.VH

EN Bed with variable height

Frame made of epoxy painted steel tube. Backrest and leg section adjustable by cranks. Variable height 50/75 cm adjustable by hydraulic pump. S.S. tube removable bed ends with laminated plastic panels. Platform fitted with weldmesh. 4 castors ø125 mm, 2 w/brakes. Bumpers at all four corners. Dimensions: 92 x 215 x 50/75 cm. Capacity: 150Kg

FR Lit avec hauteur variable

Cadre en tube d'acier epoxy. Relève-buste et relève-jambes réglables par manivelles. Hauteur variable 50/75 cm réglables par vérin hydraulique. Tube amovible en acier inox avec tête et pied de lit à panneaux laminés. Sommier en treillis métallique soudé. 4 roues, ø125 mm 2 avec frein. Galets pare-chocs aux coins. Dimensions: 92 x 215 x 50/75 cm. Capacité: 150Kg

IT Letto con altezza variabile

Struttura in acciaio verniciato. Alzatesta e poggia gambe regolabili tramite manovelle. Altezza variabile 50/75 cm regolabile con pompa idraulica. Testate estraibili in tubo di acciaio inox con pannelli in laminato plastico. Piano rete in maglia rigida. 4 ruote ø125 mm, 2 con freni. Paracolpi in tutti e quattro gli angoli. Dimensioni: 92 x 215 x 50/75 cm. Capacità: 150Kg

01.300.VH



01.301.VH



01.303.VH





01.300.TRGVH

EN Bed with variable height and TR/RTR

Frame made of rectangular section 50 x 30 x 2 mm steel tube.

Backrest and leg section adjustable by cranks.

Trendelenburg (10°) and reverse Trendelenburg (15°) adjustable by gas pump. Variable height 50/75 cm adjustable by hydraulic pump.

Stainless steel tube removable bed ends with laminated plastic panels.

Platform fitted with steel weldmesh 4 castors ø125 mm, 2 w/brakes.

Bumpers at all four corners

Dimensions: 92 x 215 x 50/75 cm.

Capacity: 150Kg

FR Lit avec hauteur variable et TR/RTR

Cadre en tube d'acier de section rectangulaire 50 x 30 x 2 mm.

Relève-buste et relève-jambes réglables par manivelles.

Trendelenburg (10°) et reverse trendelenburg (15°) réglables par pompes à gaz.

Hauteur variable 50/75 cm réglables par vérin hydraulique.

Tube amovible en acier inox avec tête et pied de lit à panneaux laminés

Sommier en treillis métallique soudé.

4 roues, ø125 mm 2 avec frein.

Galets pare-chocs aux coins.

Dimensions: 92 x 215 x 50/75 cm.

Capacité: 150Kg

IT Letto con altezza variabile e TR/RTR

Struttura in acciaio con tubo rettangolare 50 x 30 x 2 mm.

Alzatesta e poggia gambe regolabili tramite manovelle.

Trendelenburg (10°) e anti trendelenburg (15°) regolabili tramite pompa a gas.

Altezza variabile 50/75 cm regolabile con pompa idraulica.

Testate estraibili in tubo di acciaio inox con pannelli in laminato plastico.

Piano rete in maglia rigida.

4 ruote ø125 mm, 2 con freni.

Paracolpi in tutti e quattro gli angoli.

Dimensioni: 92 x 215 x 50/75 cm.

Capacità: 150Kg



01.301.TRGVH



01.303.TRGVH



**C110081**

- Collapsible side rails aluminum top bar, S.S. vertical bars
- Barrières latérales déroulantes en aluminium et acier inox
- Barriere laterali abbattibili in alluminio e in acciaio inox

**C110088**

- Side rails reclining full length. With S.S. tube and plastic ends
- Barrières de lit rabattables. Avec tube en acier inox et plastique
- Sponde laterali ribaltabili con tubo in acciaio inox e plastica

**C110086**

Lifting pole / Potence de lit / Alza malato

02.631.00

IV stand / Porte-sérum / Asta flebo

**C110085**

- "Balkan" beam frame chrome plated steel tube
- Cadre "Balkan" Bâti métallique en acier chromé
- Intelaiatura Balcanica in acciaio cromato

**C110080**

- Mosquito net epoxy painted steel tube
- Porte moustiquaire tube d'acier, époxy
- Zanzariera per letto in acciaio verniciato

**01.1001**

- Laminated plastic panels, without frame
- Panneaux laminés, sans cadre
- Testate in laminato plastico

Colors / Couleurs / Colori

**01.101.97**

- ABS panel, with support for I.V. stand
- Panneaux en ABS avec support pour porte serum
- Testate in ABS, con supporto per asta flebo

**C110855**

- Bed pan holder
- Porte bassin de lit
- Supporto per Padella

**C110856**

- Male urinal holder
- Porte urinal
- Supporto per pappagallo

**C110857**

- Urine bag holder
- Porte poche à urine
- Supporto per sacca d'urina

**01.600.00**

- Chart stand with S.S. clamp
- Porte feuille avec crochet en acier inox
- Porta cartelle con pinza in acciaio inox

**C110093.0X**

- ON REQUEST
Various slings
- SUR DEMANDE
Divers slings
- A RICHIESTA
Varie imbragature

C110093**EN Patient lift**

Steel structure in epoxy glossy finish surface
Push handle. 2 rear castors \varnothing 100 mm. with independent brake and 2 castors \varnothing 80 mm.
Dimensions: 65/113 x 126,3 x 56/161cm
Max loading 150Kg.

FR Lève-malade

Structure en acier avec revêtement époxy.
Poignée à coins arrondis. 2 roues \varnothing 100mm avec frein indépendant et 2 roues \varnothing 80mm.
Dimensions: 65/113 x 126,3 x 56/161cm
Poids maximal: 150Kg

IT Sollevatore paziente

Struttura in acciaio verniciato. Maniglia di spinta. 2 ruote posteriori \varnothing 100 mm. con freno indipendente e 2 ruote anteriori \varnothing 80 mm
Dimensioni: 65/113 x 126,3 x 56/161cm
Carico massimo: 150Kg

**C110084**

EN Lifting pole with base, made of epoxy painted tubular steel

FR Potence sur pied, structure en tube d'acier, revêtement époxy

IT Alza malato con struttura in acciaio con base verniciata

**02.881.00**

- Backrest made of S.S tube
- Relève-buste tube en acier inox
- Alzatesta in acciaio inox



02.885.00
Child / Enfant / Bambino

02.885.00

- Bed cradle made of chrome plated tube.
- Arceau de lit en tube d'acier chromé.
- Alza coperte in acciaio cromato.



Dim.: 58 x 38 x 50cm

C150102

- Overbed table with foldable legs
- Plateau de lit en ABS avec pieds repliables
- Tavolo pasto con gambe pieghevoli

**01.951.00****EN Long term care bed**

4 sections electric bed. Back-rest (0° - 75°), Leg section (0° - 30°) Variable height Trendelenburg (10°) Anti-Trendelenburg (15°) adjustable by wired remote. Sliding wooden bed side rails. 4 castors \varnothing 100 mm, 2 with brakes.
Dimensions: 104 x 212 x 30/70 cm.
Capacity: 180Kg

FR Lit médicalisé

Lit médicalisé 4 sections. Relève-buste (0° - 75°), Relève-jambes (0° - 30°) Hauteur variable, Trendelenburg (10°) Reverse Trendelenburg (15°) réglables par télécommande de filaire. Barrières coulissantes en bois. 4 roues \varnothing 100 mm, 2 avec frein.
Dimensions: 104 x 212 x 30/70 cm.
Capacité: 180Kg

IT Letto per casa di cura

Letto elettrico a 4 sezioni. Alzatesta (0° - 75°), sezione gambe (0° - 30°) altezza variabile regolabili tramite telecomando. TRT e Anti-TRT. Spondine laterali del letto in legno scorrevoli. 4 ruote \varnothing 100 mm, 2 con freno.
Dimensioni: 104 x 212 x 30/70 cm.
Capacità: 180 kg





01.500.00

EN Multi-functions ICU bed

Full-fowler bed with removable ABS plastic head and foot panels. Backrest: 0-75°, knee rest 0-40° by cranks. Collapsible side rails. Epoxy coated mild steel frame work and 4 section perforated top. Mounted on ø 125mm noiseless castors. Two drainage hooks for urine bags. Dimensions: 208 x 96 x 50 (H) cm. Capacity: 250 Kg

FR Lit hospitalier pour soins intensifs

Lit avec position de Fowler totale, avec panneaux tête et pieds amovibles, en ABS. Dossier: 0-75° - Section genoux 0-40° réglables par manivelles. Barrières latérales déroulantes. Fourni avec 4 roues silencieuses 125 mm ø. Livré avec deux crochets de drainage pour poches à urine. Dimensions: 208 x 96 x 50 (H) cm. Capacité: 250 Kg

IT Letto per terapia intensiva

Letto fowler con testate in ABS removibili. Schienale: 0-75°, poggiambracci 0-40° regolabili tramite manovelle. Sponde laterali pieghevoli. Piano forato a 4 sezioni. 4 ruote ø 125mm. Fornito con due ganci di drenaggio per sacche per urina. Dimensioni: 208 x 96 x 50 (H) cm. Portata: 250 Kg



01.501.00

EN Multi-functions ICU bed

Three-functions bed with removable ABS plastic head and foot panels. Backrest 0-75°, knee rest 0-45° and variable height 43/73 cm by cranks. Roller bumpers. Collapsible side rails. 4 ø 125mm castors. Provision for I.V. rod (not included). Supplied with four drainage hooks for urine bags. Dimensions: 216 x 95 x 43/73 (H) cm. Capacity: 250 Kg

FR Lit hospitalier pour soins intensifs

Lit manuel 3 sections avec panneaux tête et pieds amovibles, en plastique ABS. Dossier 0-75°, section genoux 0-45°, hauteur variable 43/73 cm réglables par manivelles. Pare-chocs roulants. Barrières latérales déroulantes. 4 roues ø 125 mm. Support de montage pour tige porte-sérum. (non-inclus) 4 crochets de drainage pour poches à urine. Dimensions: 216 x 95 x 43/73 (H) cm. Capacité: 250 Kg

IT Letto per terapia intensiva

Letto a 3 sezioni con testate in ABS removibili, alzatesta 0-75°, poggiambracci 0-45° e altezza variabile 43/73 cm regolabili tramite manovelle. Paracolpi a rulli. Sponde laterali pieghevoli. Piano forato a 4 sezioni. Ruote da ø 125mm. Predisposizione per asta porta flebo. 4 ganci per sacche per urina. Dimensioni: 216 x 95 x 43/73 (H) cm. Portata: 250 Kg



**01.5009****EN Multi-functions icu bed**

High quality ABS frame. Control panel on foot board. Battery backup. 4 easy lifting side rails with integrated remote. With trendelenburg and reverse trendelenburg (0 - 15°). 4 castors ø150mm with central locking system. Removable bed ends. Dimensions: 105 x 233 x 53/71 cm. Capacity: 250Kg

FR Lit hospitalier pour soins intensifs

Plastique ABS haute qualité. Panneau de commande sur pied de lit. Batterie de secours. Barrières latérales avec commandes intégrées. 4 roues silencieuses (ø150 mm) avec système de blocage centralisé. Avec trendelenburg et trendelenburg inversé (0 - 15°). Tête et pied de lit amovibles. Dimensions: 105 x 233 x 53/71 cm. Capacité: 250Kg

TRENDLENBURG
and REVERSE**IT Letto per terapia intensiva**

Telaio in ABS di alta qualità. Pannello di controllo sulla pediera. Batteria di riserva. Quattro sponde laterali pieghevoli con comando integrato. 4 ruote ø150mm con freno simultaneo. Con trendelenburg e reverse trendelenburg (0 - 15°). Testate in plastica ABS rimovibili. Dimensioni: 105 x 233 x 53/71 cm. Capacità: 250 kg

**01.5010****EN Multi-functions icu bed**

High quality ABS frame. Control panel on foot board. Battery backup. 4 easy lifting side rails with integrated remote. 4 castors ø150mm with central locking system. With trendelenburg and reverse trendelenburg (0 - 15°). Removable bed ends. Quick release lever for emergency CPR. Dimensions: 105 x 233 x 53/71 cm. Capacity: 250Kg

FR Lit hospitalier pour soins intensifs

Plastique ABS haute qualité. Panneau de commande sur pied de lit. Batterie de secours. Barrières latérales avec commandes intégrées. 4 roues silencieuses (ø150 mm) avec système de blocage centralisé. Avec trendelenburg et trendelenburg inversé (0 - 15°). Tête et pied de lit amovibles. Levier rapide retour, pour CPR d'urgence. Dimensions: 105 x 233 x 53/71 cm. Capacité: 250Kg

BACKREST
RELÈVE-BUSTEFOOTREST
RELÈVE-JAMBESVARIABLE HEIGHT
HAUTEUR VARIABLETRENDLENBURG
and REVERSEEMERGENCY CPR
CPR D'URGENCE**IT Letto per terapia intensiva**

Telaio in ABS di alta qualità. Pannello di controllo sulla pediera. Batteria di riserva. Quattro sponde laterali pieghevoli con comando integrato. 4 ruote ø150mm con freno simultaneo. Con trendelenburg e reverse trendelenburg (0 - 15°). Testate in plastica ABS rimovibili. Con leva a sgancio rapido di emergenza. Dimensioni: 105 x 233 x 53/71 cm. Capacità: 250 kg



01

EN Multi-functions ICU bed

Removable ABS head and foot panels equipped with safety lock. Four easy lifting, safe and reliable side rails. All functions through remote control. Mounted on \varnothing 125mm castors with central braking system. Epoxy coated mild steel frame and 4 section perforated top 4 drainage hooks. Dimensions: 215 x 104 x 42/73 (H) cm. Capacity: 250 Kg

01.5012 Bed with trendelenburg and reverse trendelenburg (0 - 15°)

FR Lit hospitalier pour soins intensifs

Panneaux tête et pieds amovibles, en ABS avec blocage de sécurité. 4 barrières latérales à soulèvement facile, sûres et fiables. Fonctions contrôlées par commande. 4 roues silencieuses 125 mm \varnothing avec système de freinage central. Structure en acier époxy et sommier 4 sections perforé. 4 crochets pour drainage. Dimensions : 215 x 104 x 42/73 (H) cm. Capacité: 250Kg

01.5012 Lit avec trendelenburg et trendelenburg inversé (0 - 15°)

IT Letto per terapia intensiva

Testate in ABS rimovibili dotati di blocco di sicurezza. 4 sponde laterali pieghevoli, sicure e affidabili. Utilizzo delle funzioni tramite telecomando. Montato su ruote \varnothing 125mm silenziose con freno simultaneo. Telaio in acciaio verniciato e piano forato a 4 sezioni. Fornito con 4 ganci di drenaggio. Dimensioni: 215 x 104 x 42/73 (H) cm. Portata: 250 Kg

01.5012 Letto con trendelenburg e anti trendelenburg (0 - 15°)



01.5013

EN Multi-functions ICU bed

Removable ABS head and foot panels with safety lock. Equipped with weighting scale (Kg/Lb), electric CPR and manual CPR, cardiac chair position, safe-exit position and separate nurse control panel. All functions controlled by motor. Supplied with ABS side rails, outer and inner control panels. Epoxy coated mild steel frame with 4 sections perforated top. Mounted on \varnothing 125mm castors with central locking system. Dimensions: 215 x 104 x 48/88 (H) cm. Capacity: 250 Kg

FR Lit hospitalier pour soins intensifs

Panneaux tête et pieds amovibles en ABS avec blocage de sécurité. Equipé avec balance (Kg/Lb), CPR électrique et manuel, position chaise cardiaque, position de sortie de sécurité et panneau de contrôle. Toutes fonctions contrôlées par moteur. Livré avec barrières latérales en ABS, panneau de contrôle externe et interne. Structure en acier époxy et sommier 4 sections perforé. 4 roues de 125 mm \varnothing avec système de freinage central. Dimensions : 215 x 104 x 48/88 (H) cm. Capacité: 250 Kg

IT Letto multifunzione per terapia intensiva

Testate in ABS rimovibili con blocco di sicurezza. Dotato di bilancia integrata (Kg / Lb), CPR elettrico e manuale, posizione di seduta cardiologica, posizione di uscita sicura e pannello di controllo. Tutte le funzioni controllate dal motore. Fornito con sponde laterali in ABS, pannelli di controllo interni ed esterni. Telaio in acciaio verniciato con piano forato a 4 sezioni. Montato su ruote \varnothing 125mm con freno simultaneo. Dimensioni: 215 x 104 x 48/88 (H) cm. Portata: 250 Kg



Colors / Couleurs / Colori

**C130106**

Dim: 42 x 42 x 80cm

EN Bedside locker

Made of painted steel sheet. Top made of ABS plastic with raised edges. Door and front of the drawer are made of edged chipboard. Mounted on 4 feet. Castors available on demand.

Available colors: white or blue.

FR Table de chevet

Bâti de tôle d'acier peinte. Plateau supérieur plastique ABS avec bords relevés. Porte et façade tiroir fabriqués en aggloméré. Monté sur 4 pieds. Roulettes disponibles sur demande

Couleurs disponibles: blanc ou bleu

IT Comodino

Lamiera d'acciaio verniciata. Top in plastica ABS con bordi rialzati. La porta e la parte anteriore del cassetto sono realizzate in truciolare bordato. Montato su 4 piedi. Ruote disponibili su richiesta

Colori disponibili: bianco o blu

C130106.10 Color blue / Couleur bleu / Colore blu

Colors / Couleurs / Colori

**C130110.01**

Dim: 62 x 42 x 77cm

EN Bedside locker with overbed table

Epoxy coated steel with shelf and perforated bottom. ABS plastic top raised edges and with 2-place bottle holder. Revolving door with 90° opening

Overbed table height adjustable (90-110 cm), 360° rotatable.

4 castors ø 50 mm with bumpers. Available colors: white or blue.

FR Table de chevet avec table de lit

En tôle d'acier avec étagère intérieure et fond perforé. Dessus et porte-bouteille à 2 places en ABS avec bords relevés. Une porte tournante avec ouverture à 90°.

Table de lit réglable en hauteur (90-110 cm), 360° rotatable.

4 roulettes ø 50 mm avec pare-chocs. Couleurs disponibles: blanc ou bleu.

IT Comodino con tavolo pasto

Struttura in acciaio verniciato, ripiano interno con fondo forato. Top e bordi in ABS con portabottiglie a 2 posti. Porta con apertura a 90°.

Tavolo in ABS regolabile in altezza (90-110 cm), orientabile a 360°

4 ruote ø 50 mm con paracolpi. Colori disponibili: bianco o blu.

C130110 Color white / Couleur blanc / Colore bianco

Colors / Couleurs / Colori

**C130111.01**

Dim: 62 x 42 x 77cm

EN Bilateral bedside locker with overbed table

Epoxy coated steel with shelf and perforated bottom. ABS plastic top raised edges and with 2-place bottle holder. Revolving door with 90° opening

Overbed table height adjustable (90-110 cm), 360° rotatable.

4 castors ø 50 mm with bumpers. Available colors: white or blue.

FR Table de chevet avec table de lit double face

En tôle d'acier avec étagère intérieure et fond perforé. Dessus et porte-bouteille à 2 places en ABS avec bords relevés. Une porte tournante avec ouverture à 90°.

Table de lit réglable en hauteur (90-110 cm), 360° rotatable.

4 roulettes ø 50 mm avec pare-chocs. Couleurs disponibles: blanc ou bleu.

IT Comodino con tavolo pasto bilaterale

Struttura in acciaio verniciato, ripiano interno con fondo forato. Top e bordi in ABS con portabottiglie a 2 posti. Porta con apertura a 90°.

Tavolo in ABS regolabile in altezza (90-110 cm), orientabile a 360°

4 ruote ø 50 mm con paracolpi. Colori disponibili: bianco o blu.

C130111 Color white / Couleur blanc / Colore bianco

**C130120**

Dim: 47 x 45 x 80cm

EN Bedside locker

Made of painted sheet steel with one drawer lockable. The top shelf is in metal. Internal metal shelf with perforated base for a better ventilation. Towel holder. Mounted on 4 castors \varnothing 50mm, 2 with brakes.

FR Table de chevet

Bâti en tôle d'acier verni avec base perforée pour une meilleure aération. Plateau supérieur en métal. Un tiroir avec serrure. Une porte avec étagère métallique. Porte-serviette. Monté sur roulettes \varnothing 50mm, 2 avec frein.

IT Comodino

Realizzato in lamiera d'acciaio verniciata con un cassetto chiudibile a chiave. Il ripiano superiore è in metallo. Ripiano interno in metallo con base forata per una migliore ventilazione. Porta asciugamani. Montato su 4 ruote \varnothing 50mm, di cui 2 con freno.

**C130115**

Dim: 58 x 45 x 83/108 h cm

EN bedside locker with overbed table

Made of painted sheet steel with one drawer lockable. The top shelf is in metal. Internal metal shelf with perforated base for a better ventilation. Towel holder. Mounted on 4 castors \varnothing 50mm

FR Table de chevet avec table de lit

Bâti en tôle d'acier verni avec base perforée pour une meilleure aération. Plateau supérieur en métal. Un tiroir avec serrure. Une porte avec étagère métallique. Porte-serviette. Monté sur roulettes \varnothing 50mm

IT Comodino con tavolo pasto

Realizzato in lamiera d'acciaio verniciata con cassetto chiudibile a chiave. Tavolo in ABS. Ripiano superiore in metallo. Ripiano interno con base forata per una migliore ventilazione. Porta asciugamani. Montato su 4 ruote \varnothing 50mm

**C150106****EN** Overbed table

Made of epoxy painted steel tube. Plastic top. Mounted on 4 castors \varnothing 50mm

FR Table de lit

Revêtement époxy. Plateau en plastique. Monté sur quatre roulettes \varnothing 50mm.

IT Tavolo pasto

Struttura in acciaio verniciato. Vassoio di plastica. Montato su quattro ruote \varnothing 50mm.

Dim: 41 x 65 x 81/134cm

**C150104****EN** Overbed table

Made of epoxy painted steel tube. Sliding tray. 4 swivel castors \varnothing 50mm, 2 with brakes.

FR Table de lit

Revêtement époxy. Plateau coulissant. Monté sur 4 roulettes \varnothing 50mm, 2 avec freins.

IT Tavolo pasto

Realizzato in acciaio verniciato. Vassoio scorrevole in ABS. 4 ruote piroettanti \varnothing 50mm, 2 con freno.

Dim: : 37 x 56 x 72/115 cm

**02.250.00****EN Cabinet**

Frame made of enamelled sheet steel. Lockable glass door. 3 adjustable s.s. shelves.

FR Armoire

Structure en acier émaillé blanc. Porte vitrée avec serrure. 3 étagères amovibles en inox.

IT Armadio

Struttura in acciaio verniciato. Porta in vetro con serratura. 3 ripiani regolabili in acciaio inox.

Dim: 52 x 35 x 138cm

**02.270.00****EN Medical cabinet**

Enamelled sheet steel. Two lockable glass doors. 3 adjustable s.s. shelves.

FR Armoire medicale

Structure en acier émaillé blanc. 2 portes vitrées avec serrures. 3 étagères amovibles en inox.

IT Armadio medico

Struttura in acciaio verniciato. 2 porte in vetro con serratura. 3 ripiani regolabili in acciaio inox.

Dim: 75 x 37 x 164cm

**02.280.00****EN Medical cabinet**

Upper section with 2 glass panels on both sides, lock and key and 2 adjustable s.s. shelves. Lower section with 2 sheet steel locking doors and removable shelf.

FR Armoire medicale

Structure en acier émaillé blanc. Haut: 2 portes vitrées avec serrures. 2 étagères amovibles en inox. Bas: 2 portes pleines avec serrure. 1 étagère amovible en inox.

IT Armadio medico

Parte superiore con due pannelli in vetro, serratura a chiave e due ripiani regolabili in acciaio inox. Parte inferiore con due ante in acciaio con serratura e ripiano estraibile in acciaio inox.

Dim: 79 x 36 x 186 h cm

**02.271.00****EN Medical cabinet**

Upper section with 2 glass panels on both sides, lock and key and 2 adjustable s.s. shelves. Lower section with 2 sheet steel locking doors and removable shelf.

FR Armoire medicale

Structure en acier émaillé blanc. Haut: 2 portes vitrées avec serrures. 2 étagères amovibles en inox. Bas: 2 portes pleines avec serrure. 1 étagère amovible en inox.

IT Armadio medico

Parte superiore con due pannelli in vetro, serratura a chiave e due ripiani regolabili in acciaio inox. Parte inferiore con due ante in acciaio con serratura e ripiano estraibile in acciaio inox.

Dim: 75 x 38 x 164cm

**C130302**

Dim: 80 x 40 x 180cm

EN Medical cabinet 2 lockable glass doors with key, 4 adjustable shelves, 4 stainless steel adjustable feet.

FR Armoire medicale 2 Portes vitrées verrouillées avec clé, 4 étagères réglables, 4 pieds réglables en acier inox.

IT Armadio medico 2 ante a vetro con serratura, 4 ripiani regolabili, 4 piedini regolabili in acciaio inox.

**C130303**

Dim: 80 x 40 x 180cm

EN Medical cabinet 2 lockable steel doors, 4 adjustable shelves, 4 s.s. adjustable feet, inner lockable medicines compartment.

FR Armoire medicale 2 portes avec serrure. 4 étagères réglables. Compartiment pour médicaments et 4 pieds réglables en acier inox.

IT Armadio medico 2 porte in acciaio con serratura, 4 ripiani regolabili, 4 piedini regolabili e scomparto interno per medicinali con serratura.

**C130304**

Dim: 80 x 40 x 180cm

EN Cabinet Made of S.S. 2 lockable glass doors with key, 4 adjustable shelves, 4 adjustable feet. 2 drawers. Lower section with 2 S.S doors.

FR Armoire Structure en acier inox. Portes vitrées verrouillées avec clé, 4 étagères réglables, 4 pieds réglables. 2 tiroirs. Partie inférieure avec 2 portes en inox.

IT Armadio Struttura in acciaio inox. 2 ante in vetro con serratura, 4 ripiani regolabili, 4 piedini regolabili. 2 cassetti. Parte inferiore con 2 porte in inox.

**C130205.01**

Dim: 80 x 40 x 180cm

EN Patient cabinet Enamelled sheet steel. Door in laminated plastic. Lock for each door, adjustable internal shelf.

FR Armoire vestiaire Bâti métallique. Portes en plastique laminé. Serrure indépendante et une étagère réglable à l'intérieur.

IT Armadio paziente Acciaio verniciato. Porta in laminato plastico. Serratura indipendente, ripiano interno regolabile.

C130200 41,5 X 50 X 190 H (cm)
 C130205 80 X 50 X 190 H (cm)
 C130210 120 X 50 X 190 H (cm)

Colors / Couleurs / Colori



**F631K****EN** Medicine cabinet

Bilaminated plastic structure. Internal narcotics compartment. Two doors with 16 compartments to drugs. Inside: 2 double containers with 32 compartments and 5 adjustable shelves. Adjustable feet. Dimensions: 100 x 60 x 190cm

FR Armoire à pharmacie

Structure en plastique bilaminée. Compartiment interne pour stupéfiants. Deux portes avec 16 compartiments à médicaments. A l'intérieur: 2 conteneurs doubles avec 32 compartiments et 5 étagères réglables. Pieds réglables.

Dimensions: 100 x 60 x 190cm

IT Armadio farmacia

Struttura in plastica bilaminata. Scomparto per narcotici interno. Due porte con 16 scomparti per farmaci. Interno: 2 contenitori doppi con 32 scomparti e 5 ripiani regolabili. Piedini regolabili.

Dimensione: 100 x 60 x 190cm

**C130310****EN** Metal cabinet

Enamelled sheet steel epoxy-coated, thickness 6/10, supplied with 4 feet with plastic tip. 1 shelf. Doors equipped with slits for ventilation

FR Armoire vestiaire

Bâti métallique, revêtement époxy, épaisseur 6/10, livrée avec 4 pieds avec embout plastique. 1 étagère. Portes équipées de fentes d'aération.

IT Armadio per spogliatoio

Struttura in lamiera d'acciaio verniciato di spessore 6/10, dotato di piedi con puntale in materiale plastico. Un ripiano superiore porta oggetti. Ante dotate di feritoie per l'aerazione.

Size / Dimension / Dimensioni

C130300 1 panel / panneau / pannello - 33 x 33 x 180 h (cm)

C130305 2 panels / panneaux / pannelli - 69 x 33 x 180 h (cm)

C130310 3 panels / panneaux / pannelli - 102 x 33 x 180 h (cm)

**C130400****EN** Shelving unit

Made of sheet steel epoxy-coated. Supplied with 5 shelves. Dimensions: 100 x 40 x 200cm

FR Étagère

Bâti métallique, revêtement époxy. Fourni avec 5 plateaux. Dimensions: 100 x 40 x 200cm

IT Scaffalatura

Struttura in acciaio verniciato. Fornito con 5 ripiani. Dimensioni: 100 x 40 x 200cm

**01.1600****EN** Modular system

Made of chrome plated steel. Adjustable shelves, mounted on 4 castors, 2 with brakes.

FR Armoire étagère modulaire

En acier chromé. Plateaux à hauteur réglable. Monté sur 4 roues, 2 avec freins.

IT Scaffalatura modulare

Struttura in acciaio cromato. Ripiani regolabili, montati su 4 ruote di cui 2 con freno.

Size / Dimension / Dimensioni

01.1600 90 x 45 x 170 H (cm)

01.1610 120 x 45 x 170 H (cm)

01.1620 150 x 45 x 170 H (cm)



Colors / Couleurs / Colori

**02.357.00**

Dim: 55 x 180 x 70cm

EN Examination couch

S.S. tube. Adjustable backrest. Top is upholstered and covered with washable plastic and flame retardant material.
Capacity: 150Kg

FR Divan d'examen

Structure en acier inox. Relève-buste réglable. Matelas rembourré avec revêtement traité anti-feu lavable.
Capacité: 150Kg

IT Lettino da visita

Struttura in acciaio inox. Schienale regolabile. Materasso imbottito con rivestimento ignifugo lavabile.
Capacità: 150 kg



Colors / Couleurs / Colori

**02.357.10**

Dim: 55 x 180 x 70cm

EN Examination couch

Epoxy painted steel tube. Adjustable backrest. Top is upholstered and covered with washable plastic and flame retardant material.
Capacity: 150Kg

FR Divan d'examen

Structure en tube en acier époxy. Relève-buste réglable. Matelas rembourré avec revêtement traité anti-feu lavable.
Capacité: 150Kg

IT Lettino da visita

Struttura in tubo di acciaio verniciato. Schienale regolabile. Materasso imbottito con rivestimento ignifugo lavabile.
Capacità: 150 kg

**02.358.00**

Dim: 55 x 180 x 80cm

EN Examination couch

Chrome-plated steel tube. Adjustable backrest. Top is upholstered and covered with washable plastic and flame retardant material.
Capacity: 150Kg

FR Divan d'examen

Structure en acier chromé. Relève-buste réglable. Matelas rembourré avec revêtement traité anti-feu lavable
Capacité: 150Kg

IT Lettino da visita

Struttura in acciaio cromato. Schienale regolabile. Materasso imbottito con rivestimento ignifugo e lavabile.
Capacità: 150 kg

**02.358.10**

Dim: 55 x 180 x 80cm

EN Examination couch

S.S. tube. Adjustable backrest. Top is upholstered and covered with washable plastic and flame retardant material. With paper roll holder.
Capacity: 150Kg

FR Divan d'examen

Structure en acier inox. Relève-buste réglable. Matelas rembourré avec revêtement traité anti-feu lavable. Avec porte-rouleau.
Capacité: 150Kg

IT Lettino da visita

Struttura in acciaio inox. Schienale regolabile. Materasso imbottito con rivestimento ignifugo e lavabile. Fornito con porta rotolo.
Capacità: 150 kg

**02.351.00**

Dim: 55 x 180 x 80cm

EN Examination couch

Epoxy painted steel. 4 rubber feet. Adjustable backrest. Top is upholstered and covered with washable plastic and flame retardant material. Capacity: 150Kg

FR Divan d'examen

Structure en acier époxy. Monté sur 4 pieds en caoutchouc. Relève-buste réglable. Matelas rembourré avec revêtement traité anti-feu lavable. Capacité: 150Kg

IT Lettino da visita

Struttura in acciaio verniciato. 4 piedini in gomma. Schienale regolabile. Materasso imbottito con rivestimento ignifugo e lavabile. Capacità: 150 kg

**02.351.01**

Dim: 55 x 180 x 80cm

EN Examination couch

Epoxy painted steel. 4 rubber feet. Adjustable backrest. Top is upholstered and covered with washable plastic and flame retardant material. Supplied with 2 drawers, 1 S.S. tray, Ø 80 mm castors. Capacity: 150Kg

FR Divan d'examen

Structure en acier époxy. Monté sur 4 pieds en caoutchouc. Relève-buste réglable. Matelas rembourré avec revêtement traité anti-feu lavable. Fourni avec 2 tiroirs, 1 plateau inox, Ø 80 mm roulettes Capacité: 150Kg

IT Lettino da visita

Struttura in acciaio verniciato. 4 piedini in gomma. Schienale regolabile. Materasso imbottito con rivestimento ignifugo e lavabile. Fornito con 2 cassetti, 1 vassoio in acciaio inox, ruote Ø 80 mm Capacità: 150 kg

**02.509.00**

Dim: 60 x 173 x 73cm

EN Foldable examination couch

Manufactured in epoxy painted steel tube. Top is upholstered with washable plastic material. Complete with carrying bag. Capacity: 150Kg

FR Divan d'examen pliant

Structure en acier époxy. Matelas rembourré avec revêtement plastique lavable. Livré avec housse de transport. Capacité: 150Kg

IT Lettino da visita pieghevole

Struttura in acciaio verniciato. Materasso imbottito con rivestimento in plastica lavabile. Fornito con custodia. Capacità: 150 kg

**02.510.00**

Dim: 60 x 173 x 73cm

EN Foldable examination couch

Manufactured in chrome-plated steel tube. Top is upholstered with washable plastic material. Complete with carrying bag. Capacity: 150Kg

FR Divan d'examen pliant

Structure en d'acier chromé. Matelas rembourré avec revêtement plastique lavable. Livré avec housse de transport. Capacité: 150Kg

IT Lettino da visita pieghevole

Struttura in acciaio cromato. Materasso imbottito con rivestimento in plastica lavabile. Fornito con custodia. Capacità: 150 kg

Colors / Couleurs / Colori

**02.361.00**

Dim: 60 x 180 x 80cm

EN Examination couch (3 sections)

Manufactured in chrome-plated steel tube. Adjustable backrest and leg sections. Top is upholstered, washable plastic material flame retardent. Capacity: 150Kg

FR Divan d'examen (3 sections)

Structure en acier chromé. Relève-buste et jambièrè réglables. Matelas rembourré avec revêtement anti-feu lavable. Capacité: 150Kg

IT Lettino da visita (3 sezioni)

Struttura in acciaio cromato. Schienale e poggia gambe regolabili. Materasso imbottito con rivestimento ignifugo e lavabile. Capacità: 150 kg

**02.359.00**

Dim: 60 x 180 x 80cm

EN Gynaecological couch

Chrome-plated steel tube. Adjustable backrest and leg sections. Top is upholstered, washable plastic material flame retardent. S.S. steel bowl ø30 cm. 2 anatomical padded leg holders. Capacity: 150Kg

FR Divan gynécologique

Structure en acier chromé. Relève-buste et jambièrè réglables. Matelas rembourré avec revêtement anti-feu lavable. Livré avec 1 cuvette en acier inox ø30 cm. Appui-jambes anatomiques. Capacité: 150Kg

IT Lettino ginecologico

Struttura in acciaio cromato. Schienale e poggia gambe regolabili. Materasso imbottito con rivestimento ignifugo e lavabile. Bacinella in acciaio inox ø30 cm. Supporto anatomico per le gambe. Capacità: 150 kg

**02.359.10**

Dim: 60 x 180 x 80cm

EN Gynaecological couch

S.S. tube. Adjustable backrest and leg sections. Top is upholstered, washable plastic material flame retardent. S.S. steel bowl ø30 cm. 2 anatomical padded leg holders. With paper roll holder. Capacity: 150Kg

FR Divan gynécologique

Structure en acier inox. Relève-buste et jambièrè réglables. Matelas rembourré avec revêtement anti-feu lavable. Livré avec 1 cuvette en acier inox ø30 cm. Appui-jambes anatomiques. Avec porte rouleau. Capacité: 150Kg

IT Lettino ginecologico

Struttura in acciaio inox. Schienale e poggia gambe regolabili. Materasso imbottito con rivestimento ignifugo e lavabile. Bacinella in acciaio inox ø30 cm. Supporto anatomico per le gambe. Fornito con porta rotolo. Capacità: 150 kg

Colors / Couleurs / Colori

**02.360.00**

Dim: 60 x 180 x 80cm

EN Gynaecological couch

Chrome-plated steel tube. Adjustable backrest and leg sections. Top is upholstered, washable plastic material flame retardent. S.S. steel bowl ø30 cm. 2 anatomical padded leg holders. Capacity: 150Kg

FR Divan gynécologique

Structure en acier chromé. Relève-buste et jambièrè réglables. Matelas rembourré avec revêtement anti-feu lavable. Livré avec 1 cuvette en acier inox ø30 cm. Appui-jambes anatomiques. Capacité: 150Kg

IT Lettino ginecologico

Struttura in acciaio cromato. Schienale e poggia gambe regolabili. Materasso imbottito con rivestimento ignifugo e lavabile. Bacinella in acciaio inox ø30 cm. Supporto anatomico per le gambe. Capacità: 150 kg

Colors / Couleurs / Colori

**02.537.00**

Dim: 60 x 180 x 58/86 H cm.

EN Examination couch

Epoxy painted sheet steel. Adjustable backrest. Upholstered top with washable plastic material. Adjustable feet and paper roll holder. Electric variable height. Capacity: 150Kg

FR Divan d'examen

Structure en acier emailé. Rèleve-buste réglable. Matelas rembourré avec revêtement lavable. Avec pieds réglables et porte rouleau. Hauteur variable électrique. Capacité: 150Kg

IT Lettino da visita

Struttura in acciaio verniciato. Schienale regolabile. Materasso imbottito con rivestimento lavabile. Con piedini regolabili e portarotolo Altezza variabile elettronicamente. Capacità: 150kg

02.537.10

Variable height by hydraulic pump / Hauteur variable par pompe hydraulique / Altezza variabile tramite pompa idraulica

Colors / Couleurs / Colori

**02.538.00**

Dim: 60 x 180 x 58/86 H cm.

EN Examination couch

Epoxy painted sheet steel. Adjustable backrest and leg section. Upholstered top with washable plastic material. Adjustable feet. Electric variable height. Capacity: 150Kg

FR Divan d'examen

Structure en acier emailé. Rèleve-buste et jambes réglable. Matelas rembourré avec revêtement lavable. Avec pieds réglables. Hauteur variable électrique. Capacité: 150Kg

IT Lettino da visita

Struttura in acciaio verniciato. Schienale e poggia gambe regolabili. Materasso imbottito con rivestimento lavabile. Piedini regolabili. Altezza variabile elettronicamente. Capacità: 150kg

02.538.10

Variable height by hydraulic pump / Hauteur variable par pompe hydraulique / Altezza variabile tramite pompa idraulica

Colors / Couleurs / Colori

**02.539.00**

Dim: 60 x 180 x 58/86 H cm.

EN Gynaecological couch

Frame made in epoxy painted sheet steel. Adjustable backrest and leg sections with anatomical leg-holders. Upholstered top with washable plastic material. Electric variable height. With adjustable feet. Capacity: 150Kg

FR Divan gynécologique

Construction en acier emailé. Rèleve-buste et jambes réglable avec appui-jambes anatomiques. Matelas rembourré avec revêtement lavable. Hauteur variable électrique. Avec pieds réglables. Capacité: 150Kg

IT Lettino ginecologico

Struttura in acciaio verniciato. Schienale e poggia gambe regolabili con supporto anatomico per le gambe. Materasso imbottito con rivestimento lavabile. Con piedini regolabili. Altezza variabile elettronicamente. Capacità: 150kg

02.539.10

Variable height by hydraulic pump / Hauteur variable par pompe hydraulique / Altezza variabile tramite pompa idraulica

Colors / Couleurs / Colori

**02.537.00R**

Dim: 55 x 180 x 58/86 H cm.

EN Examination couch

Epoxy painted sheet steel. Adjustable backrest. Upholstered top with washable plastic material. Adjustable feet and paper roll holder. Electric variable height. Capacity: 150Kg

FR Divan d'examen

Structure en acier emailé. Rèleve-buste réglable. Matelas rembourré avec revêtement lavable. Avec pieds réglables et porte rouleau. Hauteur variable électrique. Capacité: 150Kg

IT Lettino da visita

Struttura in acciaio verniciato. Schienale regolabile. Materasso imbottito con rivestimento lavabile. Con piedini regolabili e portarotolo Altezza variabile elettronicamente. Capacità: 150kg

02.537.10R

Variable height by hydraulic pump / Hauteur variable par pompe hydraulique / Altezza variabile tramite pompa idraulica

Colors / Couleurs / Colori

**02.538.00R**

Dim: 55 x 180 x 58/86 H cm.

EN Examination couch

Epoxy painted sheet steel. Adjustable backrest and leg section. Upholstered top with washable plastic material. Adjustable feet. Electric variable height. Capacity: 150Kg

FR Divan d'examen

Structure en acier emailé. Rèleve-buste et jambes réglable. Matelas rembourré avec revêtement lavable. Avec pieds réglables. Hauteur variable électrique. Capacité: 150Kg

IT Lettino da visita

Struttura in acciaio verniciato. Schienale e poggia gambe regolabili. Materasso imbottito con rivestimento lavabile. Con piedini regolabili. Altezza variabile elettronicamente. Capacità: 150kg

02.538.10R

Variable height by hydraulic pump / Hauteur variable par pompe hydraulique / Altezza variabile tramite pompa idraulica

Colors / Couleurs / Colori

**02.539.00R**

Dim: 55 x 180 x 58/86 H cm.

EN Gynaecological couch

Frame made in epoxy painted sheet steel. Adjustable backrest and leg sections with anatomical leg-holders. Upholstered top with washable plastic material. Electric variable height. With adjustable feet. Capacity: 150Kg

FR Divan gynécologique

Construction en acier emailé. Rèleve-buste et jambes réglable avec appui-jambes anatomiques. Matelas rembourré avec revêtement lavable. Hauteur variable électrique. Avec pieds réglables. Capacité: 150Kg

IT Lettino ginecologico

Struttura in acciaio verniciato. Schienale e poggia gambe regolabili con Supporto anatomico per le gambe. Materasso imbottito con rivestimento lavabile. Con piedini regolabili. Altezza variabile elettronicamente. Capacità: 150kg

02.539.10R

Variable height by hydraulic pump / Hauteur variable par pompe hydraulique / Altezza variabile tramite pompa idraulica

**02.2852.00****EN** Delivery bed

With padded shoulder rest, handgrips. Manufactured in chrome plated steel tube. Three sections with independent controls and pelvic trendelenburg position (0-25°). Top is upholstered with washable plastic material flame retardant. Dimensions: 55 x 180 x 80cm. Capacity: 150Kg

FR Table d'accouchement

Avec epaulières rembourrées et poignées de maintien. Structure en acier chromé. 3 sections indépendantes: relève-buste, assise et jambière. Avec position de trendelenburg pelvien (0-25°). Matelas rembourré avec revêtement lavable anti-feu. Dimensions: 55 x 180 x 80cm. Capacité: 150Kg

**02.2851.00**

Without shoulder rest and handgrips
Sans epaulières et poignées de maintien
Fornito senza reggispolle e maniglie

IT Letto parto

Fornito con spalle imbottite e maniglie laterali. Struttura in acciaio cromato. Tre sezioni indipendenti: alzatesta, poggia gambe e posizione trendelenburg pelvico (0-25°). Materassi imbottiti con rivestimento ignifugo e lavabile. Dimensioni: 55 x 180 x 80cm. Capacità: 150Kg

**02.2861.10****EN** Delivery bed

Backrest adjustable by crank. Made of epoxy coated steel tube. Section: body section mounted on four rubber feet and leg section mounted on four 100mm diam. castors, two of which with brake. Dimensions: Section 1: 80 x 120 x 80cm. Section 2: 76 x 60 x 80cm. Capacity: 150Kg

FR Table d'accouchement

Relève-buste réglable par crémaillère. Structure en tube d'acier époxy. 2 sections indépendantes: couchage sur piètement fixe et jambière mobile sur roulettes 100mm diam., dont deux avec freins. Dimensions: Section 1: 80 x 120 x 80cm. Section 2: 76 x 60 x 80cm. Capacité: 150Kg

**02.2861.00**

Without backrest / Sans relève-buste / Senza Alza testa

IT Letto parto

Schienale regolabile tramite cremagliera. Struttura in acciaio verniciato. Due sezioni indipendenti: schienale su base fissa e poggia gambe montato su 4 ruote 100mm diam., 2 con freno. Dimensioni: Sezione 1: 80 x 120 x 80cm. Sezione 2: 76 x 60 x 80cm. Capacità: 150Kg

**02.2858.00****EN** Delivery bed

Made of stainless steel tube. Third section sliding under the seat. Top is upholstered with washable and flame retardant plastic material. Complete with s.s. bowl and two adjustable leg holders.

02.2858.01 Epoxy painted tube.
Dimensions: 80 x 180 x 80cm
Capacity: 150Kg

FR Table d'accouchement

Structure en tube d'acier inox. Troisième section coulissant sous la siege. Matelas rembourré avec revêtement lavable anti-feu. Appui-jambes anatomiques réglables et 1 cuvette inox.

02.2858.01 Structure en tube d'acier époxy.
Dimensions: 80 x 180 x 80cm
Capacité: 150Kg

IT Letto parto

Struttura in acciaio inox. Terza sezione scorrevole sotto il sedile. Materassi imbottiti con rivestimento ignifugo e lavabile. Poggia gambe anatomiche regolabile. Bacinella in acciaio inox

02.2858.01 Struttura in acciaio verniciato.
Dimensioni: 80 x 180 x 80cm
Capacità: 150Kg

**02.2858.01TRG****EN** Delivery bed with Trendelenburg

Epoxy painted tube. Third section sliding under the seat. With position pelvic trendelenburg (0-25°). Top is upholstered with washable and flame retardant plastic material. S.s. bowl and 2 adjustable leg holders.

02.2858.00TRG Stainless steel tube
Dimensions: 80 x 180 x 80cm
Capacity: 150Kg

FR Table d'accouchement avec Trendelenburg

Structure en tube d'acier époxy. Troisième section coulissant sous la siege. Avec position de trendelenburg pelvien (0-25°). Matelas rembourré avec revêtement lavable anti-feu. Appui-jambes anatomiques réglables et 1 cuvette inox.

02.2858.00TRG Structure en tube d'acier inox
Dimensions: 80 x 180 x 80cm
Capacité: 150Kg

IT Letto parto con Trendelenburg

Struttura in acciaio verniciato. Terza sezione scorrevole sotto il sedile. Posizione trendelenburg pelvico (0-25°). Materassi imbottiti con rivestimento ignifugo e lavabile. Cosciali anatomici regolabili. Bacinella in inox.

02.2858.00TRG Struttura in acciaio inox
Dimensioni: 80 x 180 x 80cm
Capacità: 150Kg

Delivery bed

Table d'accouchement

Letto parto



Our delivery beds were designed and developed together with a team of doctors, working for various healthcare organizations in various parts of the world. The result is a product that combines robustness, flexibility of use and high safety standards for patient and operator. Built with a steel structure of important section and diameter on a wide base, they have a great stability during the operations. The patient frame is separate and with safety locks to prevent accidental damage to operators. The various sections are widely adjustable and the leg section can be pulled out. It can also slide under seat section. They can be equipped with various devices such as sides rails, handles and accessory bar.

Nos lits d'accouchement ont été conçus et développés en collaboration avec une équipe de médecins, travaillant pour diverses organisations de santé dans différentes parties du monde. Le résultat est un produit qui allie robustesse, souplesse d'utilisation et normes de sécurité élevées pour le patient et l'opérateur. Construits avec une structure en acier de section et de diamètre importants sur une base large, ils ont une grande stabilité pendant les opérations. Le cadre du patient est séparé et doté de verrous de sécurité pour éviter tout dommage accidentel aux opérateurs. Les différentes sections sont largement réglables et la partie jambes escamotable et coulissant sous la section du siège. Ils peuvent être équipés de divers accessoires tels que des barrières, des poignées et une barre d'accessoires.

I nostri letti parto sono stati progettati e sviluppati insieme a un team di medici, che lavorano per varie organizzazioni sanitarie in diverse parti del mondo. Il risultato è un prodotto che unisce robustezza, flessibilità di utilizzo ed elevati standard di sicurezza per paziente e operatore. Costruiti con una struttura in acciaio di sezione e diametro importanti su un'ampia base, hanno una grande stabilità durante le operazioni. Il telaio del paziente è separato e dotato di chiusure di sicurezza per evitare danni accidentali agli operatori. Le varie sezioni sono ampiamente regolabili e la sezione poggia gambe è scorrevole sotto il sedile. Possono essere dotati di vari accessori come spondine laterali, maniglie e barre porta accessori.



C110801

Side handles
Poignées latérales
Maniglie laterali



02.2856.05

Pair of leg holders
Paire de appui-jambes
Coppia di poggia gambe



02.359.15

Pair of leg holders
Paire de appui-jambes
Coppia di poggia gambe



02.359.05

Leg holders anatomical
Appui-jambes anatomique
Poggia gambe anatomici



02.2851.03

Heel stirrups
Tallonnière
Talloniere



C110803

Pair of shoulder rest
Paire de épaulières
Coppia di spalliere per lettini



C110083

Epoxy painted foldable side rails
Rails latéraux pliables en acier époxy
Sponde laterali pieghevoli in acciaio verniciato



C110804

Steel basket
Panier
Cestino porta oggetti

**02.2****EN** Delivery bed

Epoxy painted tube. With pelvic trendelenburg position (0-25°). Mounted on 4 adjustable rubber feet. Back section and pelvic section adjustable by rack. Patient hand grips, removable bowl and knee crutches holder welded to the frame.
Dimensions: 80 x 180 x 80cm
Capacity: 150Kg

FR Table d'accouchement

Structure en tube d'acier époxy. position de trendelenburg pelvien (0-25°). Monté sur 4 pieds réglables. Relève-buste et assise réglable par crémaillère. Poignées de maintien. Appui-jambes réglables en largeur et hauteur. Une cuvette escamotable.
Dimensions: 80 x 180 x 80cm
Capacité: 150Kg

IT Letto parto

Struttura d'acciaio verniciato. Con posizione trendelenburg pelvico (0-25°). Sedile regolabile tramite cremagliera. Maniglie laterali. Poggiagambe regolabili in altezza. Bacinella a scomparsa in acciaio inox. Montato su 4 piedini regolabili.
Dimensioni: 80 x 180 x 80 cm
Capacità: 150 kg

**02.2862.00****EN** Delivery bed

Epoxy coated steel square tube. Foot section mounted on rails sliding under the main frame. Adjustments of backrest by rack. With pelvic trendelenburg position (0-25°). Stainless steel sliding bowl.
Dimensions: 80 x 180 x 80cm
Capacity: 150Kg

FR Table d'accouchement

Structure en tube d'acier époxy. Jambière escamotable sous le châssis principal par glissières. Relève-buste à crémaillère. Avec position de trendelenburg pelvien (0-25°). Cuvette en acier inox coulissant sous le siège.
Dimensions: 80 x 180 x 80cm
Capacité: 150Kg

IT Letto parto

Struttura in tubo d'acciaio verniciato. Sezione poggia gambe scorrevole sotto il sedile. Alzatesta regolabile tramite cremagliera. Con posizione trendelenburg pelvico (0-25°). Bacinella in acciaio inox sotto il sedile.
Dimensioni: 80 x 180 x 80cm
Capacità: 150Kg



0:

EN Delivery bed

Epoxy painted steel tube. Anatomical leg rest. Variable height adjustable by hydraulic pedal. Back section adjustable by rack. Supplied with pelvic trendelenburg position (0-25°) adjustable by rack. Fixed mattresses covered by washable and flame retardant leatherette. S.S bowls for liquid. Dimensions: 82 x 160/200 x 64/92 h cm Capacity: 220 kg

FR Table d'accouchement

Structure en tube d'acier époxy. Repose-jambes anatomique. Hauteur réglable par pédale hydraulique. Relève-buste réglable à crémaillère. Fourni avec position trendelenburg pelvique (0-25°) réglable à crémaillère. Matelas fixes lavable et ignifuge. Cuvette en acier inox coulissant sous le siège. Dimensions: 82 x 160/200 x 64/92 h cm Capacité: 220 kg

IT Letto parto

Struttura in acciaio verniciato. Poggia gambe anatomico regolabile. Altezza variabile tramite pompa idraulica. Schienale regolabile con cremagliera. Fornito con trendelenburg pelvico (0-25°) regolabile con cremagliera. Materassi con rivestimento ignifugo e lavabile. Bacinella in acciaio inox. Dimensioni: 82 x 160/200 x 64/92 h cm Capacità: 220 kg



02.2837.001RG

EN Delivery bed

Epoxy painted steel tube. Anatomical leg rest. Variable height adjustable by hydraulic pedal. Back section adjustable by rack. Trendelenburg and reverse Trendelenburg positions (0-15°) adjustable by gas pump. S.S. bowls for liquid. Dimensions: 82 x 160/200 x 64/92 h cm Capacity: 220 kg

FR Table d'accouchement

En tube d'acier époxy. Repose-jambes anatomique. Hauteur réglable par pédale hydraulique. Relève-buste réglable par crémaillère. Position de Trendelenburg et Trendelenburg inversé (0-15°) réglable par pompe a gaz. Cuvette en acier inox. Dimensions: 82 x 160/200 x 64/92 h cm Capacité: 220 kg

IT Letto parto

Struttura in acciaio verniciato. Poggia gambe anatomico regolabile. Altezza variabile tramite pompa idraulica. Schienale regolabile con cremagliera. Posizione Trendelenburg e anti Trendelenburg (0-15°) regolabile con pompa a gas. Bacinella in acciaio inox. Dimensioni: 82 x 160/200 x 64/92 h cm Capacità: 220 kg



All removable mattresses
Tous matelas amovibles
Tutti i materassi sono removibili



02.2863.00

EN Delivery bed

Epoxy painted steel tube, Supplied with comfortable anatomical adjustable leg rest. Foldable side rails. Mounted on 4x125 mm castors, 2 with brakes. Variable height adjustable by hydraulic pedal. Back section adjustable by rack. Trendelenburg and reverse Trendelenburg position (0-15°) adjustable by gas pump. Dimensions: 90 x 160/200 x 64/88 h cm Capacity: 220 kg

FR Table d'accouchement

En acier peint en époxy. Repose-jambes anatomique confortable réglable. Barrières latérales escamotables. Monté sur roulettes 4x125 mm, 2 avec freins. Hauteur variable par pédale hydraulique. Relève-buste réglable par crémaillère. Position de Trendelenburg et Trendelenburg inversé (0-15°) réglable par pompe à gaz. Dimensions: 90 x 160/200 x 64/88 h cm Capacité: 220 kg

IT Letto parto

Struttura in tubolare d'acciaio verniciato. Poggiagambe anatomico. Spondine laterali a scomparsa. Montato su 4 ruote da 125 mm, 2 con freno. Altezza variabile tramite pompa idraulica. Schienale regolabile con cremagliera. Posizione Trendelenburg e anti Trendelenburg (0-15°) regolabile tramite pompa a gas. Dimensioni: 90 x 160/200 x 64/88 h cm Capacità: 220 kg

All removable mattresses
Tous matelas amovibles
Tutti i materassi sono removibili



02.2863.00E

EN Delivery bed

Variable height adjustable by motor. Back section adjustable by rack, leg section can be pulled out. It can also slide under seat section. Trendelenburg and reverse Trendelenburg position (0-15°) adjustable by gas pump. Dimensions: 90 x 160/200 x 64/88 h cm Capacity: 220 kg

FR Table d'accouchement

Hauteur variable par moteur. Relève-buste réglable par crémaillère. Partie jambes escamotable et coulissant sous la section du siège. Position de Trendelenburg et Trendelenburg inversé (0-15°) réglable par pompe à gaz. Dimensions: 90 x 160/200 x 64/88 h cm Capacité: 220 kg

IT Letto parto

Altezza variabile tramite motore elettrico. Schienale regolabile con cremagliera. Sezione poggia gambe scorrevole sotto il sedile. Posizione Trendelenburg e anti Trendelenburg (0-15°) regolabile tramite pompa a gas. Dimensioni: 90 x 160/200 x 64/88 h cm Capacità: 220 kg

**EN** Child cot

Made of epoxy-painted tubular steel tube, steel mesh platform. Drop down side rails with safety catches. Four \varnothing 100 mm casters, two with brakes. Capacity: 50Kg

FR Lit parc

Structure en tube d'acier revêtement époxy. Sommier en treillis métallique rigide. Barrières coulissantes avec dispositif de sécurité. 4 roues \varnothing 100 mm, dont 2 avec frein. Capacité: 50Kg

IT Lettino bambino

Struttura in acciaio verniciato con polveri epossidiche Rete in maglia rigida. Barriere scorrevoli con dispositivo di sicurezza. 4 ruote \varnothing 100 mm, di cui 2 con freno. Capacità: 50 kg

REF.	DIM.	ON REQUEST/ SUR DEMAND / A RICHIESTA
01.750.00	100x65x100H cm	With backrest
01.760.00	130x65x100H cm	Avec relève-buste
01.770.00	150x65x100H cm	Con alzatesta

**EN** Child cot with trendelenburg

Made of epoxy-painted tubular steel tube, steel mesh platform. Drop down side rails with safety catches. Four \varnothing 100 mm casters, two with brakes. With position Trendelenburg / Reverse Trendelenburg position. Capacity: 50Kg

FR Lit parc avec trendelenburg

Structure en tube d'acier revêtement époxy. Sommier en treillis métallique rigide. Barrières coulissantes avec dispositif de sécurité. 4 roues \varnothing 100 mm, dont 2 avec frein. Position de Trendelenburg et Trendelenburg inversé. Capacité: 50Kg

IT Lettino bambino con trendelenburg

Struttura in acciaio verniciato. Rete in maglia rigida. Sponde scorrevoli con dispositivo di sicurezza. 4 ruote \varnothing 100 mm, di cui 2 con freno. Posizione Trendelenburg / Anti Trendelenburg. Capacità: 50 kg

REF.	DIM.
01.751.00	100x65x100H cm
01.761.00	130x65x100H cm
01.771.00	150x65x100H cm

**EN** Child cot with variable height

Made of epoxy-painted tubular steel tube, steel mesh platform. Drop down side rails with safety catches. Four \varnothing 100 mm casters two with brakes. Capacity: 50Kg

FR Lit parc avec hauteur variable

Structure en tube d'acier revêtement époxy. Sommier en treillis métallique rigide. Barrières coulissantes avec dispositif de sécurité. 4 roues \varnothing 100 mm, dont 2 avec frein. Capacité: 50Kg

IT Lettino bambino con altezza variabile

Struttura in acciaio verniciato. Rete in maglia rigida. Sponde scorrevoli con dispositivo di sicurezza. 4 ruote \varnothing 100 mm, di cui 2 con freno. Capacità: 50 kg

REF.	DIM.
01.753.00	100x65x70/90H cm
01.763.00	130x65x70/90H cm
01.773.00	150x65x70/90H cm



EN Baby crib

Mounted on four casters \varnothing 60 mm. Crib made of plexiglas, with aeration holes and with Trendelenburg / Reverse Trendelenburg positions. Mattress not included.

Dimensions: 45 x 80 x 91 cm. Capacity: 50Kg

FR Berceau coque

Coque en plexiglas transparent avec orifices d'aération. Position de Trendelenburg et Trendelenburg inversé. Monté sur roulettes \varnothing 60 mm. Matelas non inclus.

Dimensions: 45 x 80 x 91 cm. Capacité: 50Kg

IT Culla per neonati

Culla in plexiglass trasparente con fori di ventilazione. Posizione Trendelenburg / Anti Trendelenburg. Montata su 4 ruote di \varnothing 60 mm. Materasso non incluso.

Dimensioni: 45 x 80 x 91 cm. Capacità: 50Kg

01.800.00

Chrome, acier chromé, acciaio cromato

01.800.10

Inox, acier inoxydable, acciaio inox

01.801.00

Epoxy, acier époxy, acciaio verniciato

01.802.00**EN** Baby crib with variable height and trendelenburg

Made of epoxy painted steel tube with variable height adjustable by gas pump. Trendelenburg / Reverse Trendelenburg positions 15° adjustable by gas pump. Crib made of plexiglas, with aeration holes. Mounted on four casters \varnothing 60 mm 2 with brake. Mattress not included.

Dimensions: 90 x 50 cm. Variable height 75/90 cm

FR Berceau coque avec hauteur variable et trendelenburg

Structure en acier époxy avec hauteur variable par pompe à gaz. Position de Trendelenburg et Trendelenburg inversé 15° réglable par pompe à gaz. Coque en plexiglas transparent avec orifices d'aération. Monté sur roulettes \varnothing 60 mm 2 avec frein. Matelas non inclus.

Dimensions: 90 x 50 cm. Hauteur variable 75/90 cm

IT Culla per neonati con altezza variabile e trendelenburg

Struttura in acciaio verniciato con altezza variabile regolabile tramite pompa a gas. Trendelenburg e anti trendelenburg 15° regolabile con pompa a gas. Culla in plexiglass trasparente con fori di ventilazione. Montata su 4 ruote da 60 mm 2 con freno. Materasso non incluso

Dimensioni: 90 x 50 cm. Altezza variabile 75/90 cm

C150100**EN** Swaddling table

Made of epoxy painted steel tube. Top and sides upholstered with washable plastic material. Laminated plastic lower shelf.

Dimensions: 66 x 117 x 90cm

FR Table à langer

Tube d'acier, revêtement époxy. Plan de couchage revêtu de vinyle lavable. Une étagère.

Dimensions: 66 x 117 x 90cm

IT Fasciatoio

Struttura in acciaio verniciato. Piano d'appoggio ricoperto con vinile lavabile. Uno scaffale.

Dimensioni: 66 x 117 x 90 cm

**C150100.01**

With 2 drawers

Avec 2 tiroirs

Con 2 cassetti



**C120050**

Dim: 55 x 180 x 80cm. H cm.

EN Patient stretcher

Made of chrome plated steel tube. I.V. stand and side rails. Mounted on 4 casters 125 mm, two with brakes. Capacity: 150Kg

FR Chariot brancard

Structure en acier chromé. Quatre roues ø125 mm, dont deux avec frein indépendant. Fourni avec tige porte-sérum et barrières latérales. Capacité: 150Kg

IT Barella

Struttura in acciaio cromato. Quattro ruote ø125 mm, di cui due con freno indipendente. Fornito con asta portaflebo e spondine laterali. Capacità: 150 kg

**C120052**

Dim: 55 x 180 x 80cm. H cm.

EN Patient stretcher

Made of epoxy painted steel tube. I.V. stand and side rails. Mounted on 4 casters 125 mm, two with brakes. Capacity: 150Kg

FR Chariot brancard

Bâti métallique, revêtement époxy. Quatre roues ø125 mm, dont deux avec frein indépendant. Fourni avec tige porte-sérum et barrières latérales. Capacité: 150Kg

IT Barella

Struttura in acciaio verniciato. Quattro ruote ø125 mm, di cui due con freno indipendente. Fornito con asta portaflebo e spondine laterali. Capacità: 150 kg

**C120051**

Dim: 55 x 180 x 80cm. H cm.

EN Patient stretcher removable top

Made of chrome plated steel tube. I.V. stand and side rails. Mounted on 4 casters 125 mm, two with brakes. Capacity: 150Kg

FR Chariot brancard plan amovible

Structure en acier chromé. Quatre roues ø125 mm, dont deux avec frein indépendant. Fourni avec tige porte-sérum et barrières latérales. Capacité: 150Kg

IT Barella con top removibile

Struttura in acciaio cromato. Quattro ruote ø125 mm, di cui due con freno indipendente. Fornito con asta portaflebo e spondine laterali. Capacità: 150 kg

**C120053**

Dim: 55 x 180 x 80cm. H cm.

EN Patient stretcher removable top

Made of epoxy painted steel tube. I.V. stand and side rails. Mounted on 4 casters 125 mm, two with brakes
Capacity: 150Kg

FR Chariot brancard plan amovible

Bâti métallique, revêtement époxy. Quatre roues ø125 mm, dont deux avec frein indépendant. Fourni avec tige porte-sérum et barrières latérales Capacité: 150Kg

IT Barella con top removibile

Struttura in acciaio verniciato. Quattro ruote ø125 mm, di cui due con freno indipendente. Fornito con asta portaflebo e spondine laterali. Capacità: 150 kg

**01.1210.00**

Dim: 72 x 200 x 70cm. H cm.

EN Patient stretcher

Made of epoxy painted steel tube. Backrest easily adjustable. I.V. stand and side rails. Mounted on four ø 200 mm casters, two of which with brakes. Capacity: 200Kg

FR Chariot brancard

Bâti métallique revêtement époxy. Relève-buste. Tige porte-sérum et barrières latérales. Quatre roues ø 200 mm, dont deux avec frein indépendant. Capacité: 200Kg

IT Barella

Struttura in acciaio verniciato. Alzatesta. Asta portaflebo e sponde laterali. Quattro ruote ø 200 mm, di cui due con freno indipendente. Capacità: 200 kg

**01.1230.00**

Dim: 65 x 195 x 70cm. H cm.

EN Patient stretcher removable top

Made of epoxy painted steel tube. Backrest easily adjustable. I.V. stand and side rails. Mounted on four ø 200 mm casters, two of which with brakes. Capacity: 200Kg

FR Chariot brancard plan amovible

Bâti métallique revêtement époxy. Relève-buste. Tige porte-sérum et barrières latérales. Quatre roues ø 200 mm, dont deux avec frein indépendant. Capacité: 200Kg

IT Barella con top removibile

Struttura in acciaio verniciato. Alzatesta. Asta portaflebo e sponde laterali. Quattro ruote ø 200 mm, di cui due con freno indipendente. Capacità: 200 kg



**C120030****EN** Patient stretcher

Patient stretcher with backrest adjustable by gas pump. Epoxy painted steel tube. Supplied with I.V. stand and side rails. Mounted on four \varnothing 200 mm casters, two with brakes.

Dimensions: 198 x 75 x 83 h cm

Capacity: 200Kg

FR Chariot brancard

Chariot brancard avec relève-buste réglable par pompe à gaz. Bâti métallique, revêtement époxy. Livré avec tige porte-sérum et barrières latérales. 4 roues \varnothing 200 mm, dont deux avec frein.

Dimensions: 198 x 75 x 83 h cm

Capacité: 200Kg

IT Barella

Barella con alzatesta regolabile tramite pompa a gas. Struttura in acciaio verniciato. Spondine laterali, asta portaflebo, 4 ruote \varnothing 200 mm, di cui due con freno.

Dimensioni: 198 x 75 x 83 h cm

Capacità: 200Kg

**C120031****EN** Patient stretcher

Patient stretcher with backrest adjustable by gas pump, variable height. Epoxy painted steel tube. Supplied with I.V. stand and side rails. Mounted on four \varnothing 200 mm casters, two with brakes.

Dimensions: 198 x 75 x 52/89 h cm

Capacity: 200Kg

FR Chariot brancard

Chariot brancard avec relève-buste réglable par pompe à gaz, hauteur variable. Bâti métallique, revêtement époxy. Livré avec tige porte-sérum et barrières latérales. 4 roues \varnothing 200 mm, dont deux avec frein.

Dimensions: 198 x 75 x 52/89 h cm

Capacité: 200Kg

IT Barella

Fornita con altezza variabile. Struttura in acciaio verniciato. Spondine laterali, asta portaflebo. Alzatesta regolabile con pompa a gas. 4 ruote \varnothing 200 mm, di cui due con freno.

Dimensioni: 198 x 75 x 52/89 h cm

Capacità: 200Kg

**C120032**

Patient stretcher with variable height, Trendelenburg and reverse Trendelenburg position (0-15°)

Chariot brancard avec hauteur variable Trendelenburg et Trendelenburg inversé (0-15°)

Barella con altezza variabile e Trendelenburg e anti Trendelenburg (0-15°)

**C120020****EN Patient stretcher**

Patient stretcher with adjustable backrest, variable height. Epoxy painted steel tube. Supplied with I.V. stand and side rails. Mounted on four \varnothing 200 mm casters, two with brakes.

Dimensions: 72 x 204 x 55/84cm
Capacity: 200Kg

FR Chariot brancard

Chariot brancard avec relève-buste, hauteur variable. Bâti métallique, revêtement époxy. Livré avec tige porte-sérum et barrières latérales. Quatre roues \varnothing 200 mm, dont deux avec frein indépendant.

Dimensions: 72 x 204 x 55/84cm
Capacité: 200Kg

IT Barella

Fornita con alzatesta, altezza variabile. Struttura in acciaio verniciato. Spondine laterali, asta portaflebo. Quattro ruote \varnothing 200 mm, di cui due con freno indipendente.

Dimensioni: 72 x 204 x 55/84cm
Capacità: 200Kg

**C120025****EN Patient stretcher**

Patient stretcher with adjustable backrest, variable height, Trendelenburg and reverse Trendelenburg position (0-15°). Epoxy painted steel tube. Supplied with I.V. stand and side rails. Mounted on four \varnothing 200 mm casters, two with brakes.

Dimensions: 72 x 204 x 55/84cm
Capacity: 200Kg

FR Chariot brancard

Chariot brancard avec relève-buste, hauteur variable, Trendelenburg et Trendelenburg inversé (0-15°). Bâti métallique, revêtement époxy. Livré avec tige porte-sérum et barrières latérales. Quatre roues \varnothing 200 mm, dont deux avec frein indépendant.

Dimensions: 72 x 204 x 55/84cm
Capacité: 200Kg

IT Barella

Fornita con alzatesta, altezza variabile, posizione Trendelenburg e anti Trendelenburg (0-15°). Struttura in acciaio verniciato. Spondine laterali, asta portaflebo. Quattro ruote \varnothing 200 mm, di cui due con freno indipendente.

Dimensioni: 72 x 204 x 55/84cm
Capacità: 200Kg



**C120039****EN** Emergency stretcher

Manual transfer stretcher single crank with height adjustment. Made of powder-coated metal sheet. Mounted on \varnothing 150 mm castors with central locking system and 5th direction wheel under the chassis. With flame retardant mattress and I.V. pole. Dimensions: 202 x 74 x 58/88 h cm. Capacity: 200 Kg

FR Brancard d'urgence

Chariot de transfert manuel, hauteur variable par manivelle. En métal revêtement époxy. Quatre roues diam. 150 mm, système de blocage central et 5ème roue directionnelle. Fourni avec son matelas autoextinguible et tige porte-sérum. Dimensions globales: 202 x 74 x 58/88 cm Capacité: 200 Kg

IT Barella per emergenza

Barella manuale con altezza variabile regolabile tramite manovella. Struttura in acciaio verniciato. Montato su quattro ruote orientabili da 150 mm e una quinta ruota direzionale. Fornita con materasso ignifugo e asta porta flebo. Dimensioni: 202 x 74 x 58/88 h cm. Capacità: 200 Kg

**C120040****EN** Emergency stretcher

Oleo-dynamic semi-automatic pedal-controlled stretcher. Steel frame. Variable height. Trendelenburg and reverse Trendelenburg position (0-15°). Supplied with: two folding siderails, adjustable I.V. pole, an oxygen-tank holder and a wide tray. Mounted on four swiveling 150 mm castors and 5th central directional wheel. Supplied with flame retardant mattress. Dimensions: 61 x 190,5 x 58/81,5 cm. Capacity: 200 Kg

FR Brancard d'urgence

Brancard oléo-dynamique à pédale à commande semi-automatique. Structure en acier. Hauteur variable, Trendelenburg et Trendelenburg inversé (0-15°). Fourni avec: deux barrières latérales rebattables, tige porte sérum, un porte-bouteille d'oxygène et un plateau. Montés sur quatre roulettes pivotantes de 150 mm et 5ème roue directionnelle centrale. Fourni avec son matelas autoextinguible. Dimensions: 61 x 190,5 x 58/81,5 cm. Capacité: 200 Kg

IT Barella per emergenza

Barella oleo-dinamica semi-automatica con comando a pedale. Struttura in acciaio. Altezza variabile, Trendelenburg e anti Trendelenburg (0-15°) regolabili tramite pedale. Due sponde pieghevoli, asta porta flebo, supporto per bombola d'ossigeno e un ampio vassoio. Montato su 4 ruote da 150 mm e una quinta ruota direzionale. Fornita di materasso ignifugo. Dimensioni: 61 x 190,5 x 58 / 81,5 cm. Capacità: 200 Kg



**C120041****EN** Emergency stretcher

Epoxy painted steel frame stretcher with adjustable height. Trendelenburg and reverse Trendelenburg position (0-15°). **X-ray translucent top. Can be used with C arm.** Removable mattress platform. Supplied with side rails, pushing handles, bumpers, universal bottle holder and 4 sockets for I.V. stand. Mounted on 4 x ø 200mm castors. Dimensions: 65 x 197 x 50/89cm. Capacity: 200Kg

FR Brancard d'urgence

Fabriqué en acier époxy avec hauteur variable. Trendelenburg et Trendelenburg inversé (0-15°). **Plan de couchage radio-transparent. Compatible avec arceau radiologique.** Cadre de couchage amovible. Fourni avec barrières latérales, poignées, galets pare-chocs, porte bouteille universel et 4 supports pour potence à sérum. Quatre roues ø 200mm. Dimensions: 65 x 197 x 50/89cm. Capacité: 200Kg

IT Barella per emergenza

Struttura in acciaio verniciato con altezza variabile. Posizioni Trendelenburg e anti Trendelenburg (0-15°). **Piano radiotrasparente compatibile con apparecchiature radiologiche.** Piano materasso amovibile. Fornito con sponde laterali, maniglie di spinta, paracolpi, asta porta flebo e supporto porta bombola. Montato su 4 ruote ø 200 mm. Dimensioni: 65 x 197 x 50/89 cm. Capacità: 200 kg



Accessories for patient stretcher / Accessoires pour chariot brancard / Accessori per barelle

**C110081**

Collapsible side rails
Barrières latérales déroulantes
Sponde laterali abbattibili

**C110083**

Epoxy painted foldable side rails suitable
Rails latéraux pliables en acier époxy
Sponde laterali in acciaio verniciato

**01.1220.00**

Steel basket
Panier
Cestino porta oggetti

**01.1221.00**

Bottle holder
Porte bouteille
Supporto porta bombole

**02.631.00**

I.V. stand for bed and stretcher
Tige porte sérum pour lit et brancard
Asta portaflebo per letti e barelle

**C120040/PM**

Monitor support
Support pour moniteur
Supporto porta monitor

Mattress for beds / Matelas pour lits / Materassi per letti

CODE	DESCRIPTION / DESCRIZIONE	DENSITY / DENSITÉ / DENSITÀ	SIZE / DIMENSIONS / DIMENSIONI
C110907	Fixed polyester cover / Housse fixe en polyester / Fodera fissa in poliestere	21 kg/mc	190 x 82 x 10 cm H
C110908	Fixed polyester cover / Housse fixe en polyester / Fodera fissa in poliestere	21 kg/mc	190 x 82 x 12 cm H
C110909	Removable and washable cotton cover / Housse coton amovible et lavable / Fodera in cotone sfoderabile e lavabile	21 kg/mc	190 x 82 x 12 cm H
C110910	Polyester cover 4 sections / Housse en polyester 4 sections / Fodera fissa in poliestere 4 sezioni	21 kg/mc	70/26/45/49 x 82 x 12 cm H
C110911	Removable and washable cotton cover 4 sections / Housse coton amovible et lavable - 4 sections / Fodera in cotone sfoderabile e lavabile 4 sezioni	21 kg/mc	70/26/45/49 x 82 x 12 cm H
C110912	Removable and washable cotton cover FLAME RETARDANT / Housse fixe en polyester ANTI FEU / Fodera in cotone sfoderabile e lavabile e IGNIFUGA	30 kg/mc	190 x 82 x 12 cm H
C110913	Removable and washable cotton cover 4 sections FLAME RETARDANT / Housse coton amovible et lavable - 4 sections ANTI FEU / Fodera in cotone sfoderabile e lavabile e IGNIFUGA 4 sezioni	30 kg/mc	70/26/45/49 x 82 x 12 cm H
C110926	Water proof cover for adult mattress / Housse imperméable pour matelas adulte / Rivestimento impermeabile per materasso adulti	/	/

Pillows / Oreillers / Cuscini

CODE	DESCRIPTION / DESCRIZIONE	SIZE / DIMENSIONS / DIMENSIONI
C110970	Pillow w/fixed cotton cover / Oreiller avec housse fixe en coton / Cuscino con rivestimento fisso in cotone	50 x 80 cm
C110971	Pillow FLAME RETARDANT w/removable cotton cover / Oreiller anti feu avec avec housse amovible en coton / Cuscino ignifugo con rivestimento sfoderabile in cotone	50 x 80 cm
C110972	Cotton cover for pillow / Housse en coton pour oreiller / Fodera per cuscino in cotone	/

Mattress for patient stretcher / Matelas pour chariot brancard / Materassi per barelle

CODE	DESCRIPTION / DESCRIZIONE	DENSITY / DENSITÉ / DENSITÀ	SIZE / DIMENSIONS / DIMENSIONI
C110922	Washable and removable water proof cover / Housse imperméable, amovible et lavable / Rivestimento impermeabile, rimovibile e lavabile	30 kg/mc	185x 65 x 10 cm H
C110923	Washable and removable water proof cover for stretcher w/back rest / Housse étanche amovible et lavable pour une civière avec relève buste / Copertura impermeabile, rimovibile e lavabile per una barella con schienale	30 kg/mc	68/117 x 65 x 10 cm H
C110923/B	Mattress for stretcher C120040 / Matelas pour chariot brancard C120040 / Materasso per barella C120040	30 kg/mc	185x 65 x 10 cm H
C110923/IM	Mattress Flame retardant for C120040 / Matelas Anti feu pour C120040 / Materasso ignifugo per barella C120040	30 kg/mc	185x 65 x 10 cm H
C110925	Water proof cover for stretcher mattress / Housse imperméable pour chariot brancard / Copertura impermeabile per barella	/	/

Mattress for child cot, baby crib / Matelas pour lit parc, berceau / Materassi per lettini bambino e culle

CODE	FOR / POUR / PER	DESCRIPTION / DESCRIZIONE	DENSITY / DENSITÉ / DENSITÀ	SIZE / DIMENSIONS / DIMENSIONI
C110914	01.750.00 / 01.751.00	Fixed polyester cover / Housse fixe en polyester / Fodera fissa in poliestere	21 kg/mc	95 x 45 x 10 cm H
C110915	01.760.00 / 01.761.00	Fixed polyester cover / Housse fixe en polyester / Fodera fissa in poliestere	21 kg/mc	125 x 60 x 10 cm H
C110916	01.770.00 / 01.771.00	Fixed polyester cover / Housse fixe en polyester / Fodera fissa in poliestere	21 kg/mc	145 x 60 x 10 cm H
C110917	01.750.00 / 01.751.00	VV/removable and washable cotton cover w/zip / Housse coton amovible et lavable, fermeture à glissière / Fodera in cotone rimovibile e lavabile, con cerniera	21 kg/mc	95 x 45 x 10 cm H
C110918	01.760.00 / 01.761.00	VV/removable and washable cotton cover w/zip / Housse coton amovible et lavable, fermeture à glissière / Fodera in cotone rimovibile e lavabile, con cerniera	21 kg/mc	125 x 60 x 10 cm H
C110919	01.770.00 / 01.771.00	VV/removable and washable cotton cover w/zip / Housse coton amovible et lavable, fermeture à glissière / Fodera in cotone rimovibile e lavabile, con cerniera	21 kg/mc	145 x 60 x 10 cm H
C110920	01.800.00 / 01.801.00	Fixed polyester cover / Housse fixe en polyester / Fodera fissa in poliestere	21 kg/mc	63 x 36 x 6 cm H
C110921	01.800.00 / 01.801.00	VV/removable and washable cotton cover w/zip / Housse coton amovible et lavable, fermeture à glissière / Fodera in cotone rimovibile e lavabile, con cerniera	21 kg/mc	60 x 33 x 6 cm H
C110927		Water proof cover for child cot mattress / Housse imperméable pour matelas de lit parc / Fodera impermeabile per materasso letto parto	/	/
C110928		Water proof cover for baby crib mattress / Housse imperméable pour matelas de berceau / Fodera impermeabile per materasso barelle	/	/

Drawsheet plastic, drape surgical, cotton sheet / Alèse plastique, drap chirurgical, drap coton / Lenzuolo chirurgico, lenzuolo in cotone

CODE	DESCRIPTION / DESCRIZIONE	DENSITY / DENSITÉ / DENSITÀ	SIZE / DIMENSIONS / DIMENSIONI
C110980	Cotton Sheet / Drap de Coton / Lenzuolo di cotone	9 g/m ²	100 x 100 cm
C110982	Drape Surgical / Drap Chirurgical / Lenzuolo chirurgico	240 g/m ²	100 x 100 cm
C110983	Drape Surgical / Drap Chirurgical / Lenzuolo chirurgico	240 g/m ²	150 x 90 cm
C110984	Cotton Sheet / Drap de Coton / Lenzuolo di cotone	9 g/m ²	180 x 90 cm
C110985	Cotton Sheet / Drap de Coton / Lenzuolo di cotone	9 g/m ²	150 x 90 cm

**C150001**

Dim: 61 x 180 x 53cm

EN Blood donor chair

Covered with washable plastic material. Adjustable backrest and leg rest. Adjustable armrests. Capacity: 130Kg

FR Fauteuil de prélèvement

Assise de plastique lavable. Mouvement du dos et des jambes, des accoudoirs réglables. Capacité: 130Kg

IT Poltrona donatori

Sedile in plastica lavabile. Alzatesta, poggia gambe e braccioli regolabili. Capacità: 130Kg

OPTIONAL

Instrument tray and drawer
Plateau à instruments et tiroir
Vassoio porta oggetti e cassetto

Colors / Couleurs / Colori

**C150002E**

Dim: 72 x 170 x 53cm.

EN Electric blood donor chair

Washable material. Height adjustable anatomical armrest, 180° rotatable. TR and RTR positions adjustable by electric motor. Capacity: 150Kg.

FR Fauteuil de prélèvement électrique

Assise de plastique lavable. Appuis-bras sont réglables en hauteur et pivotent à 180°. Positions TR and RTR réglables par moteur électriques. Capacité: 150Kg

IT Poltrona donatori elettrica

Sedile in plastica lavabile. Braccioli sono regolabili in altezza e ruotano di 180°. Posizioni TR and RTR regolabili tramite motore elettrico. Capacità: 150 kg

Available configurations / Configurations disponibles / Configurazioni disponibili

C150002

Adjustable by gas pump
Réglables par pompe à gaz
Regolabile tramite pompa a gas

C150002/R

Adjustable by gas pump with castors
Réglables par pompe à gaz avec roues
Regolabile tramite pompa a gas con ruote

Colors / Couleurs / Colori

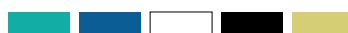
**C150006**

Dim: 72 x 163 x 50cm.

EN Blood donor chair

Washable material. Height adjustable anatomical armrest, 180° rotatable. TR and RTR positions adjustable by gas pump. Capacity: 150Kg.

FR Fauteuil de prélèvement

Assise de plastique lavable. Appuis-bras sont réglables en hauteur et pivotent à 180°. Positions TR and RTR réglables par pompe à gaz. Capacité: 150Kg

IT Poltrona donatori

Sedile in plastica lavabile. Braccioli sono regolabili in altezza e ruotano di 180°. Posizioni TR and RTR regolabili tramite pompa a gas. Capacità: 150 kg

Available configurations / Configurations disponibles / Configurazioni disponibili

C150006E

Adjustable by electric motor
Réglables par moteur électrique
Regolabile tramite motore elettrico

C150006/R

Adjustable by gas pump with castors
Réglables par pompe à gaz avec roues
Regolabile tramite pompa a gas con ruote

Colors / Couleurs / Colori

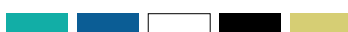



OTTO01

MIXED DECIMAL 3 MT
DECIMALE MISTA 3 MT



OTTO02

MIXED DECIMAL 5 MT
DECIMALE MISTA 5 MT



OTTO03

MONOYER 3 MT



OTTO04

ARMAGNAC 5 MT



OTTO05

CHILD / ENFANT 3 MT
BAMBINO 3 MT

EN Optotype

Wall-mounting. Acrylic screen. Steel enameled structure. Back-light.

FR Échelle d'acuité visuelle

Montage mural. Écran acrylique. Bâti en acier émaillé époxy. Rétroéclairage.

IT Ottotipi

Montaggio a parete. Schermo in acrilico. Telaio in acciaio verniciato. Retroilluminazione.

Code	Screen Écran Schermo	Dim.	Kg
OTTO01	24x62 (cm)	31x68 (cm)	6,3Kg
OTTO02			
OTTO03			
OTTO04			
OTTO05			

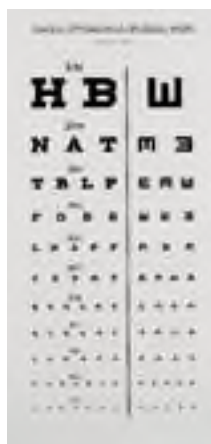

OTTO11

MIXED DECIMAL 3 MT
DECIMALE MISTA 3 MT



OTTO12

MIXED DECIMAL 5 MT
DECIMALE MISTA 5 MT



OTTO13

MONOYER 3 MT



OTTO14

ARMAGNAC 5 MT



OTTO15

CHILD / ENFANT 3 MT
BAMBINO 3 MT

EN Screen

Wall-mounting. Acrylic screen.

FR Écran

Montage mural. Écran acrylique.

IT Schermo

Montaggio a parete. Schermo in acrilico.

Code	Screen/Écran/Schermo	Kg
OTTO11	24x62 (cm)	750g
OTTO12		
OTTO13		
OTTO14		
OTTO15		



02.045.00

Dim: 41,5 x 27,5 x 13cm

EN X-ray film viewer table model

Enamelled sheet steel. Fluorescent cold light. Unbreakable white monochromatic diffuser with supporting device.

FR Négatoscope modèle de table

Acier émaillé. Lumière froide fluorescente. Diffuseur blanc monochromatique. Incassable.

IT Negativoscopio da tavolo

Lamiera in acciaio verniciato. Luce fredda fluorescente. Diffusore monocromatico bianco. Infrangibile



02.160.00

02.120.00

02.080.00

02.040.00

EN X-ray film viewers

Wall model. Enamelled sheet steel.
Fluorescent cold light.
Unbreakable white monochromatic diffuser
with supporting device.

FR Négatoscope

Modèle mural. Acier émaillé.
Lumière froide fluorescente.
Diffuseur blanc monochromatique.
Incassable.

IT Negativoscopi

Modello da parete in acciaio verniciato.
Luce fredda fluorescente.
Diffusore bianco monocromatico.
Infrangibile.

Dimensions / Dimension / Dimensioni

02.040.00 38,5 x 43,5 x 12 cm

02.080.00 77 x 43,5 x 12 cm

02.120.00 120 x 43,5 x 12 cm

02.160.00 154 x 43,5 x 12 cm



02.081.00

02.081.10

02.041.00

02.041.10

EN LED thin x-ray film viewer

Frame made of aluminum alloy and plastic.
LED light. Wall-mounting.

FR Négatoscope LED ultra mince

Cadre en alliage d'aluminium et plastique
Lumière à LED. Montage mural.

IT Negativoscopi a LED

Modello da parete in alluminio e plastica.
Illuminazione LED.

Dimensions / Dimension / Dimensioni

Without light regulator

Sans régulateur de lumière

Senza regolatore per la luce

02.041.00 47 x 54,5 x 2,4 cm

02.081.00 83 x 54,5 x 2,4 cm

With light regulator

Avec régulateur de lumière

Con regolatore per la luce

02.041.10 47 x 54,5 x 2,4 cm

02.081.10 83 x 54,5 x 2,4 cm

**02.724.00****EN Examination LED Lamp**

LED examination light, supplied on plastic base with 5 castors.

FR Lampe d'examen LED

Lampe d'examen LED fournie sur une base en plastique avec 5 roulettes.

IT Lampe da visita LED

Lampada da visita fornita su una base in plastica con 5 ruote.

Light intensity / Intensité lumineuse / Intensità della luce 40000 lux 50cm
30000 lux 1m
Colour temp. / Temp. de couleur / Temp. del colore $\pm 5\%$ a 7000 K
Service life / Durée de la lampe / Autonomia ≥ 30.000 h
Power supply / Alimentation / Alimentazione 175/250V 50/60Hz



Stainless steel
Acier inox
Acciaio inox

02.733.00**EN Examination Lamp**

Chrome plated steel tube. Foldable stainless steel base with 5 castors.

FR Lampe d'examen

Tube d'acier chromé. Piètement démontable en acier inoxydable avec 5 roulettes.

IT Lampe da visita

Tubo in acciaio cromato. Base smontabile in acciaio inox con 5 ruote

**02.738.00****EN Examination LED Lamp**

Chrome plated steel tube. Supplied on plastic base with 5 castors

FR Lampe d'examen LED

Tube d'acier chromé. Sur une base en plastique avec 5 roulettes.

IT Lampada da visita LED

Tubo d'acciaio cromato. Base in plastica con 5 ruote

Light intensity / Intensité lumineuse / Intensità della luce 20000lux at 50cm
Colour temp. / Temp. de couleur / Temp. del colore 4000 \pm 200K
Service life / Durée de la lampe / Autonomia ≥ 30.000 h
Power supply / Alimentation / Alimentazione 110-220V/50Hz-60Hz

**02.738.00H****EN Examination halogen Lamp**

Examination light with adjustable arm, supplied on plastic base with 5 castors.

FR Lampe d'examen halogène

Lampe d'examen avec bras réglable fournie sur une base en plastique avec 5 roulettes.

IT Lampada da visita alogena

Lampada da visita con braccio orientabile fornita su una base in plastica con 5 ruote.

Light intensity / Intensité lumineuse / Intensità della luce 20000lux at 50cm
Colour temp. / Temp. de couleur / Temp. del colore 4000K \pm 200K
Service life / Durée de la lampe / Autonomia ≥ 30.000 h
Power supply / Alimentation / Alimentazione 110-220V/50Hz-60Hz

EN Examination lampExamination lamp supplied on plastic base with 5 castors **WITH BATTERY****02.720.00** Halogen light**02.721.00** LED light**FR Lampe d'examen**Lampe d'examen fournie sur une base en plastique avec 5 roulettes. **AVEC BATTERIE****02.720.00** Lampe halogène**02.721.00** Lampe LED**IT Lampada da visita**Lampada da visita fornita su una base di plastica con 5 ruote. **CON BATTERIA****02.720.00** Lampada alogena**02.721.00** Lampada a LEDDimming
Variateur
Regolatore
d'intensità**TECHNICAL PARAMETERS / PARAMÈTRES TECHNIQUES / SPECIFICHE TECNICHE****Code**Light intensity / Intensité lumineuse /
intensità della luce

Colour temp. / Temp. de couleur / Temp. del colore

Total irradiance/ total des irradiance / Irradiazione totale

Lamp head Ø/ Ø de la lampe / Ø della lampada

Service life / Durée de la lampe / Autonomia

Battery operating / Avec batterie / Batteria

Rated power of bulb / Puissance nominale de l'ampoule /
Potenza della lampadina

Power supply / Alimentation / Alimentazione

02.720.00

20,000 Lux @0.4m

5,000 Lux @1m

3800 °K (±200 °K)

380W/m²

75 mm

≥2000 h

√

12V/35W

AC220-50Hz

02.721.00

30,000 Lux @0.4m

5,000 Lux @1m

4000 °K (±200 °K)

380W/m²

75 mm

≥20000 h

√

12V/7W

AC220-50Hz

**EN****LED lamp**Lamp with
adjustable
intensity.**FR****Lampe d'opération LED**Lampe
à LED
à intensité
réglable.**IT****Lampada operatoria a LED**Lampada
operatoria
a LED
a luminosità
regolabile.Light intensity / Intensité lumineuse / Intensità della luce
Colour temp. / Temp. de couleur / Temp. del colore
Head diameter / Diamètre tête / Diam. testa
Voltage / Tension / Voltaggio≥60,000Lux
4800K±300K
150 mm
240V - 50/60 Hz**02.745.00****EN Operating halogen lamp**Operating lamp with adjustable light
intensity. Supplied with integrated
rechargeable battery for operation
without mains electricity.**FR Lampe d'opération halogène**Lampe d'opération avec intensité
lumineuse réglable. Fourni avec une
batterie rechargeable intégrée pour
opération sans électricité.**IT Lampada operatoria alogena**Lampada operatoria con intensità
luminosa regolabile. Fornito con una
batteria ricaricabile integrata per il
funzionamento senza elettricità.Light intensity / Intensité lumineuse / Intensità della luce
Colour temp. / Temp. de couleur / Temp. del colore
Voltage / Tension / Voltaggio
Battery life / Autonomie / Autonomia batteria≥60,000Lux
3,789±200K
220V - 50Hz
≥3 hours

**EN** Operating halogen lamp

Operating halogen light with flexible Ø 800mm employable supporting frame, meet requirements of all kinds of hospital

FR Lampe d'opération halogène

Lampe d'opération halogène avec le cadre soutenant employable Ø 800mm flexible, répond aux conditions de toutes sortes d'hôpital

IT Lampada operatoria alogena

Lampada operatoria alogena con telaio di supporto flessibile Ø 800 mm, soddisfa i requisiti di tutti i tipi di ospedali

FL500 Without battery / Sans batterie
Senza batteria

FL500B with battery / avec batterie
Con batteria

**EN** Operating LED Lamp

Operating LED light with flexible Ø 800mm employable supporting frame, meets requirements of all kinds of hospital

FR Lampe d'opération LED

Lampe d'opération LED avec le cadre soutenant employable Ø 800mm flexible, répond aux conditions de toutes sortes d'hôpital

IT Lampada operatoria LED

Lampada operatoria a LED con telaio di supporto flessibile Ø 800 mm, soddisfa i requisiti di tutti i tipi di ospedali

FL500LED Without battery / Sans batterie / Senza batteria

FL500BLED With battery / Avec batterie / Con batteria

Light intensity / Intensité lumineuse / Intensità della luce 40,000-90,000
Colour temp. / Temp. de couleur / Temp. del colore 4500k±500k
Power / Alimentation / Alimentazione 150W

Light intensity / Intensité lumineuse / Intensità della luce 100,000
Colour temp. / Temp. de couleur / Temp. del colore 4500k±500k
LED Power / Alimentation / Alimentazione 54W

**FLE500AS****FLE700A****EN** LED Surgical light

All aluminium alloy body for a longer service time. Multiple LED bulbs insuring a perfect shadowless rate and a cold theater. Scientific head shape for best laminar flow air clean system. LCD touch screen sensitive and stable to adjust. Convenience illumination, colour temperature, colour rendering index, light spot or camera focus (option)

FR Eclairage opératoire LED

Corps en alliage d'aluminium pour une durée de vie plus longue. Combinaison d'ampoules LED assurant un éclairage optimal sans augmentation de température. Une forme de coupole étudiée pour permettre un nettoyage optimal en flux laminaire. Écran de contrôle tactile LCD sensible et stable pour ajuster la température de couleur, indice de rendu des couleurs, point lumineux ou mise au point de la caméra (en option)

IT Lampade operatorie chirurgiche LED

Corpo in lega di alluminio per una maggiore durata. Combinazione di lampadine a LED per garantire un'illuminazione ottimale senza aumentare temperatura e senza ombre. Una forma a cupola progettata per consentire una pulizia ottimale. Schermo touchscreen LCD sensibile e stabile per regolare la temperatura colore, indice di resa cromatica, punto luminoso o fuoco della fotocamera (opzionale)

Code / Code / Codici

FLE500AS single
FLE500A double (500+700)
FLE700AS single
FLE700A double (700+700)

AVAILABLE CONF. / CONF. DISPONIBLE / CONF. DISPONIBILI

Ceiling mounted / Monté au plafond / Montaggio a soffitto
Wall mounted / Mural / Montaggio a parete
Mobile type / Type mobile / Mobile
Single or double head / Tête unique et doubles / Tetsa unica e doppia
With or without camera / Avec ou sans caméra / Con o senza fotocamera

**FM300****EN** Manual hydraulic surgical table

Main controls are located on the head section and consist of two big levers that drive all table movements (TR/ RTR, chest elevation, lateral tilting). Meets all the requirements for chest, abdominal, gynaecological and obstetric, ophthalmological and otorhinolaryngological, urological, colon, rectal, and orthopaedic surgery. Base, lifting column, accessories rail and accessories are made of stainless steel, easy to clean and rustproof. Lifting column is adjustable by means of a hydraulic system. Lifting column has a central position and is studied to avoid tilting. Dimensions: 52 x 200 x 78/102cm. Capacity: 200Kg

FR Table d'opération manuelle hydraulique

Répond à toutes les exigences liées à la chirurgie thoracique, abdominale, gynécologique/obstétrique, ophtalmologique/ORL, rectale et orthopédique. Fabriquée en matériaux de haute qualité et selon des technologies de précision. Ergonomique, les commandes principales, placées au niveau de la tête, contrôlent tous les mouvements de la table (Trendelenburg, Trendelenburg inversé, élévation du buste, inclinaison latérale). Base et accessoires sont en acier inox, faciles à nettoyer et anti-rouille. Sûre, les mouvements de la colonne centrale anti-bascule sont réglables par système hydraulique. Dimensions: 52 x 200 x 78/102cm. Capacité: 200Kg

IT Tavolo operatorio idraulico

Soddisfa tutti i requisiti relativi alla chirurgia toracica, addominale, ginecologica / ostetrica, oftalmologica / ORL, rettale e ortopedica. Realizzato con materiali di alta qualità e secondo tecnologie di precisione. Ergonomico, i comandi principali, posizionati a livello del poggiatesta, controllano tutti i movimenti del tavolo (TR, RTR, altezza variabile, inclinazione laterale). Base e accessori sono realizzati in acciaio inossidabile, facili da pulire e antiruggine. Sicuro, i movimenti della colonna centrale anti-ribaltamento sono regolabili dal sistema idraulico. Dimensioni: 52 x 200 x 78/102cm. Capacità: 200Kg

ACCESSORIES / ACCESSOIRES / ACCESSORI

Anaesthesia screen / Ecran d'anesthésie	1 pcs
Seamless rubber mattress / Matelas sans coutures	1 set
Shoulder supp./ Supp. épaule / Supp. Spalle	2 pcs
Oilcan / burette d'huile / Oliatore	1 pcs
Arm support / Support bras / Supp. braccia	2 pcs
Long fixing clamp / Pincés fixation longues / morsetto per fissaggio	4 pcs
Body support / Support latéral / Supp. laterale	2 pcs
Fixation clamps / Pincés fixation / Pinze fissaggio	2 pcs
Leg support / Support jambe / Supp. gambe	2 pcs
Head plate / Plateau-tête / Supp. per testa	1 pcs

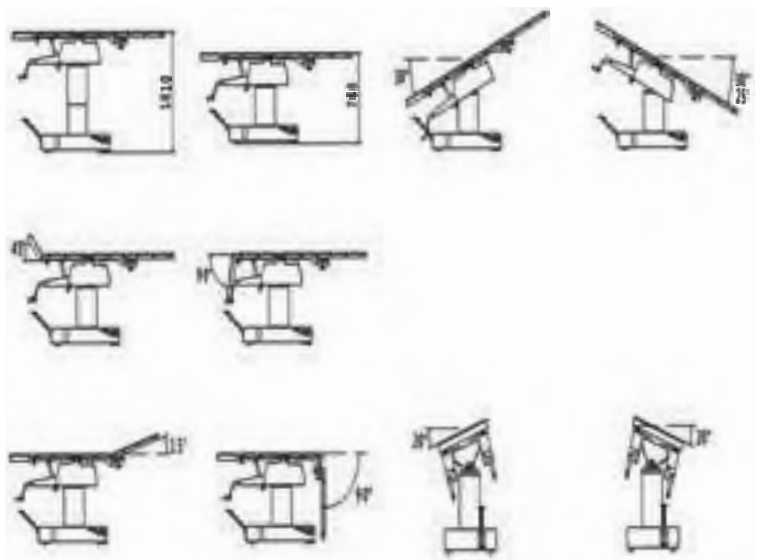

TECHNICAL DATA / DONNÉES TECHNIQUES / SPECIFICHE TECNICHE

Trendelenburg & rev.	≥22°
Lateral tilt / Inclinaison latérale / Inclinazione laterale	≥18°
Head plate / Section tête / Sezione testa	+45°/-70°
Leg plate / Section jambes / Sezione gambe	+15°/-85°
Leg plate (Ext) / Section jambes (Ext) / Sezione gambe esterne	+90°

**FM500****EN** Manual hydraulic surgical table

OPERATING TABLE FOR FISTULA REPAIR
Main controls are located on the head section and consist of two big levers that drive all table movements (TR/ RTR, chest elevation, lateral tilting). Meets all the requirements for chest, abdominal, gynaecological and obstetric, ophthalmological and otorhinolaryngological, urological, colon, rectal, and orthopaedic surgery. Base, lifting column, accessories rail and accessories are made of stainless steel, easy to clean and rustproof. Lifting column is adjustable by means of a hydraulic system. Lifting column has a central position and is studied to avoid tilting.

Dimensions: 52 x 200 x 78/102cm.

Capacity: 200Kg

FR Table d'opération manuelle hydraulique

TABLE D'OPÉRATION POUR RÉPARATION DE LA FISTULE, Répond à toutes les exigences liées à la chirurgie thoracique, abdominale, gynécologique/obstétrique, ophtalmologique/ORL, rectale et orthopédique. Fabriquée en matériaux de haute qualité et selon des technologies de précision. Ergonomique, les commandes principales, placées au niveau de la tête, contrôlent tous les mouvements de la table (Trendelenburg, Trendelenburg inversé, élévation du buste, inclinaison laterale). Base et accessoires sont en acier inox, faciles à nettoyer et anti-rouille. Sûre, les mouvements de la colonne centrale anti-bascule sont réglables par système hydraulique.

Dimensions: 52 x 200 x 78/102cm.

Capacité: 200Kg

IT Tavolo operatorio idraulico

TAVOLO OPERATORIO PER LA RIPARAZIONE DELLA FISTOLA. Soddisfa tutti i requisiti relativi alla chirurgia toracica, addominale, ginecologica / ostetrica, oftalmologica / ORL, rettale e ortopedica. Realizzato con materiali di alta qualità e secondo tecnologie di precisione. Ergonomico, i comandi principali, posizionati a livello del poggiatesta, controllano tutti i movimenti del tavolo (TR, RTR, altezza variabile, inclinazione laterale). Base e accessori sono realizzati in acciaio inossidabile, facili da pulire e anti-ruggine. Sicuro, i movimenti della colonna centrale anti-ribaltamento sono regolabili dal sistema idraulico.

Dimensioni: 52 x 200 x 78/102cm.

Capacità: 200Kg



ACCESSORIES / ACCESSOIRES / ACCESSORI

Anaesthesia screen / Ecran d'anesthésie	1 pcs
Seamless rubber mattress / Matelas sans coutures	1 set
Shoulder supp./ Supp. épaule / Supp. Spalle	2 pcs
Oilcan / burette d'huile / Oliatore	1 pcs
Arm support / Support bras / Supp. braccia	2 pcs
long fixing clamp / Pinces fixation longues / morsetto per fissaggio	4 pcs
Body support / Support latéral / Supp. laterale	2 pcs
Fixation clamps / Pinces fixation / Pinze fissaggio	2 pcs
Leg support / Support jambe / Supp. gambe	2 pcs
Head plate / Plateau-tête / Supp. per testa	1 pcs

TECHNICAL DATA / DONNÉES TECHNIQUES / SPECIFICHE TECNICHE

Trendelenburg & rev.	≥45°
Lateral tilt / Inclinaison latérale / Inclinazione laterale	≥20°
Head plate / Section tête / Sezione testa	+45°/-70°
leg plate / Section jambes / Sezione gambe	+15°/-85°
leg plate (Ext) / Section jambes (Ext) / Sezione gambe esterne	+90°

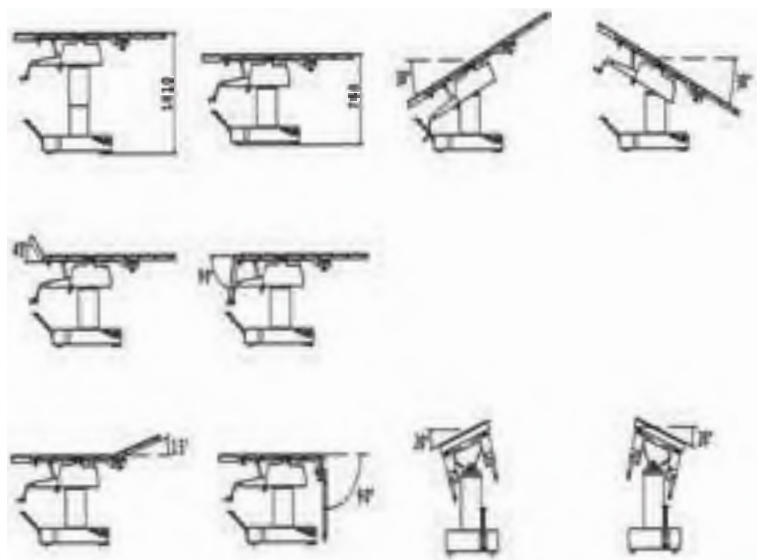

**FE30G****EN** Electric surgical table

The movements of the table (TR/RTR, chest elevation, lateral tilting) can be controlled by means of a remote control. Meets all the requirements for surgery thoracic, abdominal, gynecological and obstetrics, ophthalmology and otorhinolaryngology, urological, colon, rectal and orthopedic surgery. Maintenance-free rechargeable batteries with capacity for about a week use in the operating room. The base, supporting column, accessories' fixation device and the accessories are made of S.S., easy to clean and rust-proof. The electric pillar is centrally located and is tested to prevent tipping. Seamless mattress in memory foam. Dimensions: 55 x 200 x 70/100cm. Capacity: 200Kg

FR Table d'opération Electrique

Répond à toutes les exigences liées à la chirurgie thoracique, abdominale, gynécologique/obstétrique, ophtalmologique/ORL, urologie, rectale et orthopédique. Ergonomique, la télécommande contrôle tous les mouvements à assistance électrique de la table (Trendelenburg, Anti-Trendelenburg, élévation du buste, inclinaison latérale). Base et accessoires sont en acier inox, faciles à nettoyer et antirouille. Les batteries rechargeables sans entretien ont une capacité d'utilisation d'une semaine en salle d'opération. Matelas en mousse à mémoire de forme, sans coutures pour une hygiène renforcée. Dimensions: 55 x 200 x 70/100cm. Capacité: 200Kg

IT Tavolo operatorio elettrico

Soddisfa tutti i requisiti relativi alla chirurgia toracica, addominale, ginecologica / ostetrica, oftalmica / ORL, urologia, rettale e ortopedica. Ergonomico, il telecomando controlla tutti i movimenti elettricamente assistiti del tavolo (Trendelenburg, Anti-Trendelenburg, sollevamento del torace, inclinazione laterale). Base e accessori sono realizzati in acciaio inossidabile, facili da pulire e antiruggine. Le batterie ricaricabili efficienti e senza manutenzione hanno una capacità di una settimana in sala operatoria. Materasso memory foam, senza cuciture per una maggiore igiene. Dimensioni: 55 x 200 x 70/100cm. Capacità: 200Kg

ACCESSORIES / ACCESSOIRES / ACCESSORI

Anaesthesia screen / Ecran d'anesthésie	1 pcs
Seamless rubber mattress / Matelas sans coutures	1 set
Shoulder supp./ Supp. épaule / Supp. Spalle	2 pcs
Oilcan / burette d'huile / Oliatore	1 pcs
Arm support / Support bras / Supp. braccia	2 pcs
Long fixing clamp / Pincés fixation longues / morsetto per fissaggio	4 pcs
Body support / Support latéral / Supp. laterale	2 pcs
Fixation clamps / Pincés fixation / Pinze fissaggio	2 pcs
Leg support / Support jambe / Supp. gambe	2 pcs
Head plate / Plateau-tête / Supp. per testa	1 pcs

TECHNICAL DATA / DONNÉES TECHNIQUES / SPECIFICHE TECNICHE

Trendelenburg & rev.	≥25°
Lateral tilt / Inclinaison latérale / Inclinazione laterale	≥15°
Head plate / Section tête / Sezione testa	+45°/-90°
Leg plate / Section jambes / Sezione gambe	+15°/-90°
Leg plate (Ext) / Section jambes (Ext) / Sezione gambe esterne	+90°

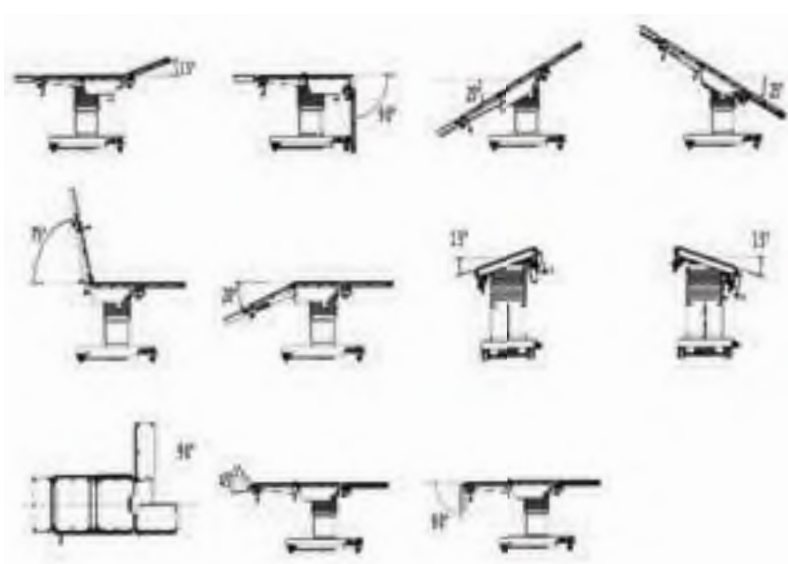

**02.2900.00****EN Veterinary surgical table**

Table in stainless steel AISI 304. Hydraulic cylinder, foot control. Double V shaped plan with stainless steel liquid collection system and removable PVC bowl. Procline / manual declivity. Adjustable feet. Dimensions: 50 x 150 x 89/116cm. Capacity: 120Kg

FR Table d'opération vétérinaire

Table en acier inox AISI 304. Vérin hydraulique, commande au pied. Double plan en V avec système de réception des liquides en acier inox et cuvette PVC amovible. Procline / déclive manuelle. Base avec pieds réglables. Dimensions: 50 x 150 x 89/116cm. Capacité: 120Kg

IT Tavolo operatorio veterinario

Tavolo in acciaio inox AISI 304. Cilindro idraulico, comando a pedale. Doppio piano a V con sistema di ricezione del liquido in acciaio inox e vasca estraibile in PVC. Inclinazione manuale. Base con piedini regolabili. Dimensioni: 50 x 150 x 89/116cm. Capacità: 120Kg

**02.2901.00**

Dim.: 60 x 130 x 89 cm

EN Veterinary table

Veterinary table in stainless steel AISI 304. Adjustable feet. Capacity: 120Kg

FR Table vétérinaire

Table vétérinaire en acier inox AISI 304. Base avec pieds réglables. Capacité: 120Kg

IT Tavolo veterinario

Tavolo veterinario in acciaio inox AISI 304. Base con piedini regolabili. Capacità: 120Kg

**02.2902.00**

Dim.: 250 x 80 x 92 cm

EN Laboratory table

Table in stainless steel AISI 304. Adjustable feet. Capacity: 120Kg

FR Table de laboratoire

Table en acier inox AISI 304. Base avec pieds réglables. Capacité: 120Kg

IT Tavolo da laboratorio

Tavolo in acciaio inox AISI 304. Base con piedini regolabili. Capacità: 120Kg

**EN Trolley**

Made of S.S. 18/10. Shelves with upstands. Push handle. \varnothing 80 mm casters.

2 Shelves / 2 plateaux / 2 ripiani
02.866.01 60 x 40 x 80 H (cm)
02.867.01 70 x 50 x 80 H (cm)
02.868.01 90 x 60 x 80 H (cm)

FR Chariot

Structure en acier inox 18/10. Plateaux à bords relevés. Poignée. Roulettes \varnothing 80 mm.

IT Carrello

Struttura in acciaio inox 18/10. Ripiani con bordo rialzato. Maniglia per spinta. Ruote \varnothing 80 mm.

3 Shelves / 3 plateaux / 3 ripiani
02.869.01 70 x 50 x 80 H (cm)

02.863.01

Dim.: 90 x 60 x 80cm

EN Trolley

Made of S.S. 18/10. Shelves with upstands. Push handle. S.S. bottle holders, trash can, and bowl \varnothing 30cm. \varnothing 80 mm casters.

FR Chariot

Structure en acier inox 18/10. Plateaux à bords relevés. Poignée. Porte-flacons, poubelle et cuvette en inox \varnothing 30cm. Roulettes \varnothing 80 mm.

IT Carrello

Struttura in acciaio inox 18/10. Ripiani con bordo rialzato. Maniglia per spinta. Portabottiglie, pattumiera e bacinella in inox \varnothing 30cm. Ruote \varnothing 80 mm.

**02.1050.01**

Dim.: 70 x 50 x 80cm

EN Trolley

Made of S.S. Shelves with upstands. Push handle. With drawer and S.S. bowl \varnothing 30 cm. \varnothing 80 mm casters.

FR Chariot

Structure en acier inox. Plateaux à bords relevés. Poignée. Avec: tiroir et cuvette inox \varnothing 30 cm. Roulettes \varnothing 80 mm.

IT Carrello

Struttura in acciaio inox. Ripiani con bordo rialzato. Maniglia per spinta. Con cassetto e bacinella in inox \varnothing 30cm. Ruote \varnothing 80 mm.

02.1051.01 With 2 drawers / Avec 2 tiroirs / Con 2 cassetti

EN Lancart trolley

Made of stainless steel tube. \varnothing 80mm castors.

FR Chariot lancart

Structure en acier inox. Monté sur roulettes \varnothing 80mm.

IT Carrello lancart

Struttura in acciaio inox. Montato su ruote da \varnothing 80mm.

2 Shelves / 2 plateaux / 2 ripiani

02.871.00 70 x 50 x 80 (h) cm

02.872.00 90 x 60 x 80 (h) cm

3 Shelves / 3 plateaux / 3 ripiani

02.871.01 70 x 50 x 80 (h) cm

02.872.01 90 x 60 x 80 (h) cm

ON REQUEST / SUR DEMANDE / A RICHIESTA

02.873.00 Guardrails / Galeries / Ringhierini



EN Trolley

Glazed S.S. AISI 304. **Removable shelves** and raised edges.

FR Chariot

En acier inox AISI 304 satiné. **Plateaux amovibles** à bords relevés.

IT Carrello

In acciaio inox AISI 304 satinato. Con **ripiani removibili** e bordi rialzati.

CODE	DIMENSION	SHELF PLATEAUX RIPIANI	CASTORS ROUES RUOTE
02.6026	60 x 40 x 81 (h) cm	2	Ø80
02.6028	80 x 50 x 83,5 (h) cm	2	Ø100
02.6030	90 x 60 x 83,5 (h) cm	2	Ø100
02.6032	110 x 70 x 87 (h) cm	2	Ø125



EN Trolley

Glazed S.S. AISI 304. **Removable shelves** and raised edges.

FR Chariot

En acier inox AISI 304 satiné. **Plateaux amovibles** à bords relevés.

IT Carrello

In acciaio inox AISI 304 satinato. Con **ripiani removibili** e bordi rialzati.

CODE	DIMENSION	SHELF PLATEAUX RIPIANI	CASTORS ROUES RUOTE
02.6027	60 x 40 x 81 (h) cm	3	Ø80
02.6029	80 x 50 x 83,5 (h) cm	3	Ø100
02.6031	90 x 60 x 83,5 (h) cm	3	Ø100
02.6033	110 x 70 x 87 (h) cm	3	Ø125



02.6106

Dim.: 85 x 55 x 87 (h)cm

EN Trolley

Made of stainless steel 18/10. Push handle. With 2 shelves and 2 drawers. ø 125mm casters.

FR Chariot

Structure en acier inox 18/10. Poignée. 2 plateaux et 2 tiroirs. Monté sur roulettes ø 125mm.

IT Carrello

Struttura in acciaio inox 18/10. Maniglia di spianta. 2 ripiani e 2 cassetti. Montato su ruote da ø 125mm.



02.6107

Dim.: 85 x 55 x 87 (h)cm

EN Trolley

Made of S.S. 18/10. Top shelf with upstands on four sides. Push handles. With 2 shelves and 3 drawers. ø 125mm casters.

FR Chariot

Structure en acier inox 18/10. Plateau supérieur avec galeries. Poignées. 2 plateaux et 3 tiroirs. Monté sur roulettes ø 125mm.

IT Carrello

Struttura in acciaio inox 18/10. Ripiani superiori con ringhierini. Maniglie di spianta. 2 ripiani e 3 cassetti. Montato su ruote da ø 125mm.

**EN** Ward trolley

Aluminium alloy frame. Plastic laminated removable shelves. Mounted on \varnothing 80mm castors.

FR Gueridon de soins

Structure en aluminium. Plateaux amovibles en laminé plastique. Monté sur roulettes \varnothing 80mm.

IT Carrello di servizio

Struttura in alluminio. Ripiani amovibili in laminato plastico. Montato su ruote \varnothing 80mm.

Without drawer / Sans tiroir / Senza cassetto

02.860.00 60 x 40 x 81 (h) cm

02.861.00 70 x 50 x 81 (h) cm

02.862.00 90 x 60 x 81 (h) cm

With drawer / Avec tiroir / Con cassetto

02.860.10 60 x 40 x 81 (h) cm

02.861.10 70 x 50 x 81 (h) cm

02.862.10 90 x 60 x 81 (h) cm

**02.6051**

Dim. 45 x 65 x 80cm

EN Ward Cart

Light alloy frame with laminated plastic shelf. With 2 shelves and 1 large drawer. \varnothing 80mm castors.

FR Chariot de soins

En alliage léger avec plateau en plastique stratifié, 2 plateaux et 1 grand tiroir. Roulettes \varnothing 80mm.

IT Carrello di servizio

Struttura in lega leggera con vassoio in plastica laminata, 2 vassoi e 1 grande cassetto. Ruote da \varnothing 80mm.



Colors / Couleurs / Colori

**02.6103**

Dim.: 55 x 85 x 87cm

EN Ward Cart

Light alloy frame with laminated plastic shelf. With 2 shelf and 2 drawers. \varnothing 80mm castors.

FR Chariot de soins

En alliage léger avec plateau en plastique stratifié, 2 plateaux et 2 tiroirs. Roulettes \varnothing 80mm.

IT Carrello di servizio

In lega leggera con piano in plastica laminata, 2 vassoi e 2 cassetti. Ruote da \varnothing 80mm.



Colors / Couleurs / Colori

**02.6006**

Dim.: 55 x 85 x 87cm

EN Ward Cart

Light alloy frame with laminated plastic shelf. 6 drawers. \varnothing 80mm castors.

FR Chariot de soins

En alliage léger avec plateau en plastique stratifié, 6 tiroirs. Roulettes \varnothing 80mm.

IT Carrello di servizio

In lega leggera con piano in plastica laminata, 6 cassetti. Ruote da \varnothing 80mm.

02.6007 With 2 drawers and cupboard with 2 doors / Avec 2 tiroirs et 1 placard avec deux portes / 2 cassetti e armadietto con 2 ante.

MODULAR CART

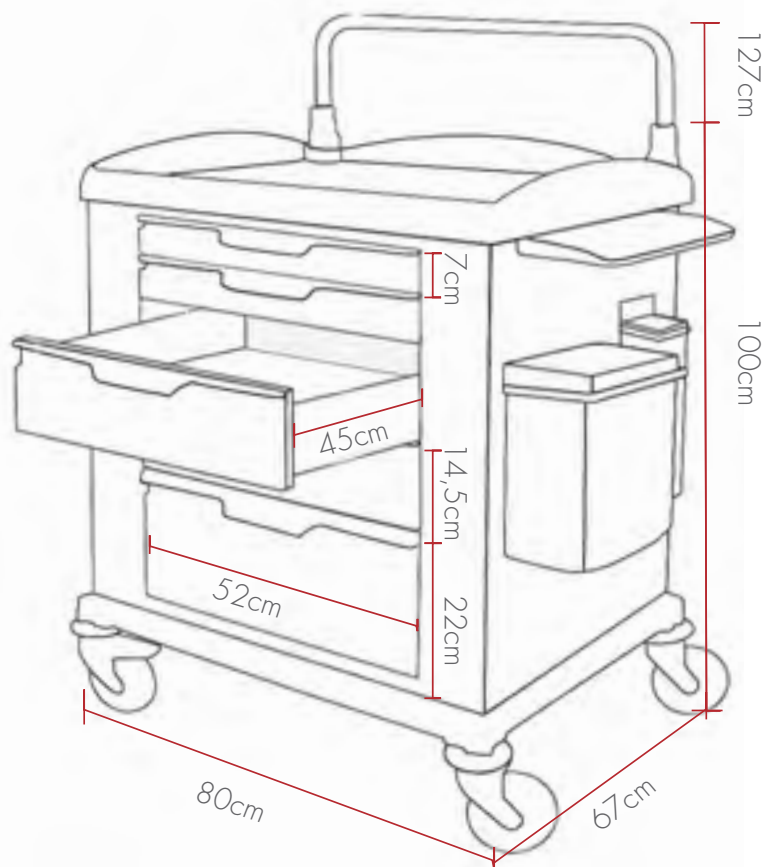

EN Modular cart

Epoxy painted steel body. Central locking system. 4 casters, two with brake, \varnothing 125mm

FR Chariot modulaire

Structure en acier peint époxy. Système de verrouillage central. 4 roulettes, deux avec frein, \varnothing 125mm

IT Carrelli modulari

Struttura in acciaio verniciato. Sistema di chiusura centralizzata. 4 ruote, 2 con freno da \varnothing 125mm



DIFFERENT CONFIGURATIONS AVAILABLE / DIFFÉRENTES CONFIGURATIONS DISPONIBLES / VARIE CONFIGURAZIONI DISPONIBILI

01.6274

EN Emergency Cart

Epoxy powder coating steel. 5 front drawers in epoxy painted steel. Massage board in transparent plexiglass. Extending table, 10 liters waste bin, 1 ABS catheter and probe holder. S.S. integrated push handle. 4 casters, two with brake, \varnothing 125mm oxygen cylinder holder. 4 PVC bumpers.

FR Chariot d'urgence

Structure en acier. 5 tiroirs frontaux en acier peint époxy. Plaque de massage en plexiglass transparent. Table extensible, poubelle 10 litres, porte-cathéter et sonde en ABS. Poignée de poussée intégrée en inox. 4 roulettes, deux avec frein, \varnothing 125mm. Porte-bouteille d'oxygène. 4 pare-chocs en PVC.

IT Carrello emergenza

Struttura in acciaio. 5 cassetti frontali in acciaio verniciato. Piastra per massaggio cardiaco in plexiglass trasparente. Ripiano estraibile, cestino da 10 litri, supporto per catetere e sonda in ABS. Maniglia di spinta in acciaio inox. 4 ruote, due con freno da \varnothing 125mm, porta bombola d'ossigeno.

Dim.: 80 x 67 x 100 cm



5 DRAWERS TIROIRS CASSETTI	DIM.
2	7 h cm
2	14,5 h cm
1	22 h cm



01.6274.01

Stainless steel cart
Chariot en acier inox
Carrello in acciaio inox

01.6192

EN Multipurpose cart

Epoxy powder coating steel. 5 front drawers in epoxy painted steel with central locking. Extending table, 10 liters waste bin, 1 ABS catheter and probe holder. S.S. integrated push handle. 4 casters, two with brake, \varnothing 125mm. Accessory bar. 4 PVC bumpers.

FR Chariot multifonction

Structure en acier. 5 tiroirs frontaux en acier peint époxy avec système de verrouillage central. Table extensible, poubelle 10 litres, porte-cathéter et sonde en ABS. Poignée de poussée intégrée en inox. 4 roulettes, deux avec frein, \varnothing 125mm. Barre pour accessoires. 4 pare-chocs en PVC.

IT Carrello multifunzione

Struttura in acciaio. 5 cassetti frontali in acciaio verniciato con chiusura centralizzata. Ripiano estraibile, cestino da 10 litri, supporto per catetere e sonda in ABS. Maniglia di spinta in acciaio inox. 4 ruote di cui due con freno da \varnothing 125mm. Barra laterale per accessori. 4 paracolpi in PVC.

Dim.: 80 x 67 x 100 cm



5	DRAWERS TIROIRS CASSETTI	DIM.
	2	7 h cm
	2	14,5 h cm
	1	22 h cm



01.6192.01

Stainless steel cart
Chariot en acier inox
Carrello in acciaio inox



4	DRAWERS TIROIRS CASSETTI	DIM.
	3	14,5 h cm
	1	22 h cm

01.6190

EN Multipurpose cart

4 front drawers in epoxy painted steel

FR Chariot multifonction

4 tiroirs frontaux en acier peint époxy

IT Carrello multifunzione

4 cassetti frontali in acciaio verniciato

01.6190.01 Stainless steel cart / Chariot en acier inox / Carrello in acciaio inox



6	DRAWERS TIROIRS CASSETTI	DIM.
	3	7 h cm
	3	14,5 h cm

01.6196

EN Multipurpose cart

6 front drawers in epoxy painted steel

FR Chariot multifonction

6 tiroirs frontaux en acier peint époxy

IT Carrello multifunzione

6 cassetti frontali in acciaio verniciato

01.6196.01 Stainless steel cart / Chariot en acier inox / Carrello in acciaio inox

**01.6168****EN** Medical records cart

Epoxy powder coating steel. 3 front drawers in epoxy painted steel with central locking. Extending table. S.S. integrated push handle. 4 casters, two with brake, ø 125mm. Supplied with 25 folder. Accessory bar. 4 PVC bumpers.

3	DRAWERS TIROIRS CASSETTI	DIM.
1		7 h cm
2		30 h cm

FR Chariot porte-dossiers

Structure en acier. 3 tiroirs frontaux en acier peint époxy avec système de verrouillage central. Table extensible. Poignée de poussée intégrée en inox. 4 roulettes, deux avec frein, ø 125mm. Fourni avec 25 dossiers. Barre pour accessoires. 4 pare-chocs en PVC.

IT Carrello porta cartelle

Struttura in acciaio. 3 cassetti frontali in acciaio verniciato con chiusura centralizzata. Ripiano estraibile. Maniglia di spinta in acciaio inox. 4 ruote da ø 125mm di cui 2 con freno. Fornita con 25 cartelle. Barra laterale per accessori. 4 paracolpi in PVC.

Dim.: 80 x 67 x 100 cm

**01.6193****EN** Anaesthesia trolley

Epoxy powder coating steel. 5 front drawers in epoxy painted steel with central locking. Extending table, 10 liters waste bin, 1 ABS catheter and probe holder. S.S. integrated push handle. 4 casters, two with brake, ø 125mm. Accessory bar. 4 PVC bumpers. Supplied with holding frame with 11 drawers.

5	DRAWERS TIROIRS CASSETTI	DIM.
2		7 h cm
2		14,5 h cm
1		22 h cm

FR Chariot d'anesthésie

Structure en acier. 5 tiroirs frontaux en acier peint époxy avec système de verrouillage central. Table extensible, poubelle 10 litres, porte-cathéter et sonde en ABS. Poignée de poussée intégrée en inox. 4 roulettes, deux avec frein, ø 125mm. Barre pour accessoires. 4 pare-chocs en PVC. Fourni avec rehausse avec 11 tiroirs.

IT Carrello per anestesia

Struttura in acciaio. 5 cassetti frontali in acciaio verniciato con chiusura centralizzata. Ripiano estraibile, cestino da 10 litri, supporto per catetere e sonda in ABS. Maniglia di spinta in acciaio inox. 4 ruote di cui due con freno da ø 125mm. Barra laterale per accessori. 4 paracolpi in PVC. Fornito con supporto con 11 cassetti modulari.

Dim.: 80 x 67 x 100 cm

**01.6193.01**

Stainless steel cart
Chariot en acier inox
Carrello in acciaio inox



DR100

DR101

DR102

AVAILABLE ON BOTH SIDES

EN Available on both sides

DR100 3 swiveling drawers with support for cardiac board in transparent plexiglas

DR101 3 swiveling drawers

DR102 1 swiveling drawer, 2 tray with metal rim and 1 bottle holder

FR Disponibles sur les deux côtés

DR100 3 tiroirs pivotants et équipé de planche de massage en plexiglas

DR101 3 tiroirs pivotants

DR102 1 tiroir pivotant 2 plateaux avec rebord et 1 porte-flacons

IT Configurazioni disponibili su entrambi i lati

DR100 3 cassetti e dotato di lastra per massaggio in plexiglass

DR101 3 cassetti basculanti

DR102 1 cassetto basculante 2 ripiani con bordo e 1 porta flaconi



DR006

Holding frame with 11 drawers
Rehausse avec 11 tiroirs
Supporto con 11 cassetti modulari



DR022

Top for cart in stainless steel
Plateau pour chariot en acier inox
Top per carrello in acciaio inox



DR001/2/3

Internal divider/ Séparateur interne / Separatori interni
DR001 small, petit, piccoli
DR002 medium, moyen, medi
DR003 large, grand, grandi



DR004

Record holder
Porte-dossiers
Porta cartelle



DR007

Probe holder
Porte sondes
Porta sonda



DR008

Waste container
Poubelle
Cestino



DR009

Disposable seals
Sceaux jetables
Sigillo monouso



DR010

Iv pole
Tige porte-sérum
Asta flebo



DR011

Monitor holder
Support moniteur
Supporto porta monitor



DR012

Instrument trays holder
Support plateau a instruments
Supporto per vassoio



DR013

Kidney bowls holder
Support haricot
Supporto per reniforme



DR015

Lamp
Lampe
Lampada



DR023

Support for suction pump
Support pour aspirateur
Supporto per aspiratore



DR024

Steel basket
Panier de rangement
Cestino porta oggetti



DR025

Bottle holder
Porte-bouteille
Porta bottiglie



DR026

Round support
Support rond
Supporto tondo



DR027

Support
Support
Supporto



DR016M

Multiple medical electrical socket MDR compliant
Prise électrique médicale multiple conforme MDR
Presca elettrica medica multipla conforme a MDR

**01.6275****EN** Emergency Cart

Emergency trolley made of ABS plastic. Supplied with CPR board, oxygen cylinder holder and needle disposable bottle. It has 5 layers of drawers, stainless steel top, 2 waste bins, 1 transparent file box, 1 sliding table, 1 monitor/defibrillator holder and 1 I.V. pole. Mounted on 4 castors diam. 10 cm, 2 with brakes.

FR Chariot d'urgence

Chariot d'urgence en plastique ABS. Livré avec un plan pour massage cardiaque, porte-bouteille d'oxygène et une bouteille pour aiguilles jetables. 5 tiroirs, 1 plateau en acier inox, 2 poubelles, 1 boîte transparente pour dossiers, 1 table coulissante, 1 porte-monitor et 1 tige porte-sérum. Monté sur 4 roulettes diam. 10 cm, 2 avec freins.

IT Carrello emergenza

Struttura in ABS. Piastra per massaggio cardiaco, porta bombola d'ossigeno e flacone per aghi monouso. 5 cassetti, top in acciaio inox, 2 pattumiere, 1 ripiano estraibile, 1 raccogliatore laterale, 1 porta monitor, 1 asta portaflebo e 4 ruote diametro 10 cm, 2 con freno.

Dim.: 85 x 52 x 96 cm

**01.6265****EN** Procedure cart

Made of ABS plastic. 6 layers of drawers which can be pulled out from both sides, self-locked when closed. 50 compartments card slot holder at the front of every compartment. 2 waste bins, 1 transparent file box, 1 sliding table and 1 hanging device supplied with 5 hooks. 4 castors diam. 10 cm, 2 with brakes

FR Chariot à médicaments

Fabriqué en plastique ABS. 6 couches de tiroirs qui peuvent être tirées des deux côtés, autobloquantes. 50 compartiments support de fente pour carte à l'avant de chaque compartiment. 2 poubelles, 1 boîte de classement transparente, 1 table coulissante et 1 accrochage fourni avec 5 crochets. 4 roulettes diam. 10 cm, 2 avec freins.

IT Carrello terapia

Struttura in ABS. 6 cassetti estraibili da entrambi i lati, autobloccanti quando chiusi. 50 scomparti di supporto per slot per schede nella parte anteriore di ogni scomparto. 2 pattumiere, 1 cassetto basculante trasparente, 1 ripiano scorrevole e 1 appendino con 5 ganci. 4 ruote diametro 10 cm, 2 con freno

Dim.: 85 x 53 x 101 cm



01.6265.01

EN Anaesthesia trolley

Made of ABS plastic. 2 waste bins, 1 transparent file box, 1 sliding table. 4 castors diam. 10 cm, 2 with brakes. Supplied with holding frame with 11 drawers.



01.6275.01

FR Chariot d'anesthésie

Fabriqué en plastique ABS. 2 poubelles, 1 boîte de classement transparente, 1 table coulissante. 4 roulettes diam. 10 cm, 2 avec freins. Fourni avec rehausse avec 11 tiroirs.

IT Carrello per anestesia

Struttura in ABS. 2 pattumiere, 1 cassetto basculante trasparente, 1 ripiano scorrevole. 4 ruote diametro 10 cm, 2 con freno. Fornito con supporto con 11 cassetti modulari.



01.6201

EN Medicine trolley

Made of ABS. 9 drawers and central locking device. 2 sliding table and 1 waste bin. 4 castors ø 10 cm, 2 with brakes.

FR Chariot de médicament

En matériel ABS. Fourni avec 9 tiroirs et séparateurs, 1 fermeture à clé. 2 tablettes coulissantes et 1 poubelle. 4 roulettes ø 10 cm, 2 avec freins.

IT Carrello medicinali

Struttura in ABS. 9 cassetti con divisori e serratura. 2 ripiani estraibili e 1 cestino. 4 ruote ø 10 cm, 2 con freno.



01.6178

EN Record holder

Made of ABS. 42 file holders. 1 drawer. 2 sliding table. S.S handle and central locking device. 4 castors ø 10 cm, 2 with brakes.

FR Chariot porte-dossiers

En matériel ABS. 42 emplacements. 1 tiroir, 2 tablettes coulissantes, 1 fermeture à clé et 1 poignée en acier inox. 4 roulettes ø 10 cm, 2 avec freins.

IT Carrello Porta cartelle

Struttura in ABS. 42 porta cartelle 1 cassetto. 2 ripiani scorrevoli. Serratura maniglia in acciaio inox. 4 ruote ø 10 cm, 2 con freno.

Dim.: 76 x 58 x 100 cm

Dim.: 76 x 58 x 100 cm

**01.6049**

Dim.: 105 x 70 x 125 cm

EN Linen trolley

S.S. frame. 270° door opening, antiodust gasket and key lock. Bumper in rubber. 4 casters ø 150mm, 2 with brake and 1 direction wheel.

FR Chariot à linge

En acier inox. Ouverture des portes à 270°. Verrouillage par clé. Galets pare-chocs. 4 roues ø 150mm, 2 avec frein et 1 directionnelle.

IT Carrello

Struttura in acciaio inox. Apertura porta a 270°. Serratura a chiave. Paracolpi. 4 ruote da ø 150mm, 2 con freno e una ruota direzionale.

**01.6143**

Dim.: 85 x 66 x 130 cm

EN Cart

Epoxy painted frame. Antiodust gasket and key lock. 180° door opening. Four casters ø 125 mm. Bumper. 2 wheels with brake.

FR Chariot

Structure en acier époxy. Système d'ouverture des portes à 180°. Joints anti-poussière. 4 roues ø125mm, dont 2 avec frein. Galets pare-chocs.

IT Carrello

Struttura in acciaio verniciato con serratura. apertura porte a 180°. 4 ruote ø125mm, di cui 2 con freno. Con paracolpi.

**01.6211**

Dim.: 85 x 67 x 100 cm

EN Cart

S.S. frame. 2 hinged doors and 3 drawers. With bag holder (on demande). 4 roulettes, 2 avec frein, ø125mm. 4 PVC bumpers.

FR Chariot

En acier inox. 2 portes battantes et 3 tiroirs. Porte-sac (sur demande). 4 roulettes, 2 avec frein, ø125mm. 4 pare-chocs en PVC.

IT Carrello

Struttura in acciaio inox. 2 ante 3 cassetti. Con porta sacco (a richiesta). 4 ruote, 2 con freno da ø125mm. 4 paracolpi in PVC.

**02.490.00**

Dim.: 40 x 65 x 110cm

EN Anaesthesia trolley

Manufactured in S.S. steel 18/10. Six drawers and storage compartment complete with shelf and locking door. Ø 80 mm casters.

FR Chariot d'anesthésie

En acier inox18/10. Six tiroirs et compartiment de rangement avec étagère et porte verrouillable. Roulettes Ø 80 mm.

IT Armadio anestesia

In acciaio inox 18/10. Sei cassetti e vano portaoggetti con ripiano e ante con serratura. Ruote Ø 80 mm.

**C140001**

Dim.: 112 x 57 x 91,5 cm

EN Linen trolley

Aluminium alloy frame. 3 removable shelves made of laminated plastic material and one bag. 4 casters Ø 125 mm.

FR Chariot à linge

Structure en aluminium. Trois étagères amovibles plastifiées et un portesac. Monté sur 4 roulettes Ø125 mm.

IT Carrello per biancheria

Struttura in alluminio. 3 ripiani in plastica removibili e un porta sacco. Montato su 4 ruote Ø125 mm.



Bag included
Sac inclus
Sacco incluso

01.7120

Dim.: 63 x 78 x 106 cm

EN Storage cart

S.S. glazed tube AISI 304. 4 Ø 80 mm swivel casters, with bumpers and bags.

FR Chariot porte-sac

En acier inox AISI 304. 4 Ø 80 mm roulettes pivotantes, avec pare-chocs. Avec sacs.

IT Porta sacco

In acciaio inox AISI 304. 4 ruote Ø 80 mm piroettanti, con paracolpi. Con sacco.

01.7110

Sigle storage cart / Chariot porte-sac simple / Porta sacco singolo (Dim.: 63 x 43 x 106 cm)



Removable bag
Sac amovible
Sacco removibile

02.840.00**EN** Single storage cart

Chrome plated frame. On Ø 80 mm casters.

FR Chariot porte-sac simple

En acier chromé. Sur roulettes Ø 80 mm.

IT Porta sacco singolo

In acciaio cromato. 3 ruote da Ø 80 mm.

02.841.00

Double storage cart / Chariot porte-sac double / Porta sacco doppio

**01.7115**

Cap.: 70lt

EN Single storage cart

Open/close controlled by pedal. 4 Ø 80 mm wheels, 2 swivel and 2 with brake.

FR Chariot porte-sac simple

Ouverture/fermeture contrôlée par pédale. 4 roues Ø 80 mm, dont 2 pivotantes et 2 avec frein.

IT Porta sacco singolo

Apertura/chiusura controllato dal pedale. 4 ruote da Ø 80 mm, di cui 2 girevoli e 2 con freno.

**02.844.00****EN** Waste bin with pedal

In stainless steel. Handle for transport. 1 front door to remove the bag (not included)

FR Poubelle avec pedal

Fabriqué en acier inox. 1 poignée. Porte pour enlever et changer le sac (non fourni)

IT Cestino con pedale

In acciaio inox. Maniglia per trasporto. Porta frontale per rimuovere il sacco (non fornito)

**02.690.00****EN** Infusion pump stand

S.S. tube. Aluminium base. 4 S.S. hooks. Weight for base. Height 180/240 cm.

FR Porte-pompe à infusion

Tube d'acier inox. Piètement en aluminium. 4 crochets en acier inox. Poids pour base. Hauteur 180/240 cm.

IT Porta pompa per infusione

Tubo in acciaio inox. Base in alluminio. 4 grucce in acciaio inox. Peso per base. Altezza 180/240 cm.

**02.694.13****EN** I.V. Stand

Stainless steel tube. Plastic base. 4 plastic hooks. Height 115/200 cm.

FR Pied à sérum

Tube d'acier inox. Piètement en plastique. 4 crochets en plastique. Hauteur 115/200 cm.

IT Asta porta flebo

Tubo in acciaio inox. Base in acciaio plastica. 4 grucce in plastica. Altezza 115/200 cm.

**02.694.60****EN** I.V. Stand

Stainless steel tube. Stainless steel base. 4 plastic hooks. Height 115/200 cm.

FR Pied à sérum

Tube d'acier inox. Piètement en acier inox. 4 crochets en plastique. Hauteur 115/200 cm.

IT Asta porta flebo

Tubo in acciaio inox. Base in acciaio inox. 4 grucce in plastica. Altezza 115/200 cm.

**02.694.61****EN** I.V. Stand

Stainless steel tube. Stainless steel base. 4 Stainless steel hooks. Height 115/200 cm.

FR Pied à sérum

Tube d'acier inox. Piètement en acier inox. 4 crochets en acier inox. Hauteur 115/200 cm.

IT Asta porta flebo

Tubo in acciaio inox. Base in acciaio inox. 4 grucce in acciaio inox. Altezza 115/200 cm.

02.694.81

With 5 antistatic castors
Avec 5 roulettes antistatiques
Con 5 ruote antistatiche

**02.694.61A****EN** I.V.Stand

Stainless steel tube.
Stainless steel base.
4 Stainless steel hooks.
Height 115/200 cm.

FR Pied à sérum

Tube d'acier inox.
Piètement en acier inox.
4 crochets en acier inox.
Hauteur 115/200 cm.

IT Asta porta flebo

Tubo in acciaio inox.
Base in acciaio inox.
4 grucce in acciaio inox.
Altezza 115/200 cm.

Ø 56 cm

**02.694.13A****EN** I.V.Stand

Stainless steel tube.
Plastic base.
4 Stainless steel hooks.
Height 115/200 cm.

FR Pied à sérum

Tube d'acier inox.
Piètement en plastique.
4 crochets en acier inox.
Hauteur 115/200 cm.

IT Asta porta flebo

Tubo in acciaio inox.
Base in plastica.
4 grucce in acciaio inox.
Altezza 115/200 cm.

Ø 58 cm

**02.694.80****EN** I.V.Stand

Stainless steel tube.
Alluminium base.
4 Stainless steel hooks.
Height 115/200 cm.

FR Pied à sérum

Tube d'acier inox.
Piètement en aluminium.
4 crochets en acier inox.
Hauteur 115/200 cm.

IT Asta porta flebo

Tubo in acciaio inox.
Base in alluminio.
4 grucce in acciaio inox.
Altezza 115/200 cm.

Ø 60 cm

ACCESSORIES FOR I.V. STAND
ACCESSOIRES POUR PIED À SÉRUM
ACCESSORI PER ASTE FLEBO
**02.702.00**

2 S.S. hooks
2 crochets en acier inox
2 grucce in inox

**02.703.00**

4 S.S. hooks
4 crochets en acier inox
4 grucce in inox

**02.694.935**

4 plastic hooks
4 crochets en plastique
4 grucce in plastica

**02.699.00**

Bottle holder
Porte-bouteille
Porta bottiglie

**PESO**

Weight for base
Poids pour base
Peso per base

**02.704.00**

Antistatic castors
Roulettes antistatiques
Ruote antistatiche



02.825.00

EN Ward screen

Chromed steel tube. Fireproof and washable plastic curtains. Mobile on wheels ø 50mm

FR Paravent

Tube d'acier chromé. Rideaux en plastique anti-feu et lavables. Mobile sur roulettes ø 50mm.

IT Paraventi

Tubo in acciaio cromato. Tende in plastica ignifughe e lavabili. Ruote da 50 mm.

- 02.824.00 2 panels / panneaux / pannelli 100x50x180 H cm
- 02.825.00 3 panels / panneaux / pannelli 150x50x180 H cm
- 02.826.00 4 panels / panneaux / pannelli 200x50x180 H cm



02.825.01

EN Ward screen

Epoxy painted steel tube. Fireproof and washable plastic curtains. Mobile on wheels ø 50mm.

FR Paravent

Tube d'acier epoxy. Rideaux en plastique anti-feu et lavables. Mobile sur roulettes ø 50mm.

IT Paraventi

Tubo in acciaio verniciato. Tende in plastica ignifughe e lavabili. Ruote da 50 mm.

- 02.824.01 2 panels / panneaux / pannelli 100x50x180 H cm
- 02.825.01 3 panels / panneaux / pannelli 150x50x180 H cm
- 02.826.01 4 panels / panneaux / pannelli 200x50x180 H cm



02.825.05

EN Ward screen

Stainless steel tube. Fireproof and washable plastic curtains. Mobile on wheels ø 50mm.

FR Paravent

Tube d'acier inox. Rideaux en plastique anti-feu et lavables. Mobile sur roulettes ø 50mm.

IT Paraventi

Tubo in acciaio inox. Tende in plastica ignifughe e lavabili. Ruote da 50 mm.

- 02.824.05 2 panels / panneaux / pannelli 100x42x167 H cm
- 02.825.05 3 panels / panneaux / pannelli 150x42x167 H cm
- 02.826.05 4 panels / panneaux / pannelli 200x42x167 H cm



02.823.00

EN Ward screen

Alluminium tubular frame. Adjustable length: 100/200 cm. Washable and flame retardant fabric 210 x 160 h cm.

FR Paravent

Tube d'aluminium Longueur réglable: 100/200 cm. Rideau en tissu anti-feu et lavables 210 x 160 h cm.

IT Paraventi

Tubo d'alluminio Lunghezza regolabile: 100/200 cm. Tenda in tessuto ignifugo e lavabile 210 x 160 h cm.

**02.48**

15cm

EN Mayo table

S.S.construction.
Variable height
85/115. Casters \varnothing
50 mm. Capacity:
25Kg

FR Table de mayo

En acier inox.
Hauteur réglable
85/115. Roulettes \varnothing
50 mm. Capacité:
25Kg

IT Tavolo Mayo

Acciaio inox.
Altezza variabile
85/115. Ruote
da \varnothing 50 mm.
Capacità: 25Kg

**02.481**

85/115cm

EN Mayo table

S.S.construction.
Variable height
85/115. Casters \varnothing
50 mm. Capacity:
25Kg

FR Table de mayo

En acier inox.
Hauteur réglable
85/115. Roulettes \varnothing
50 mm. Capacité:
25Kg

IT Tavolo Mayo

Acciaio inox.
Altezza variabile
85/115. Ruote
da \varnothing 50 mm.
Capacità: 25Kg



Hydraulic pump
Vérin hydraulique
Pompa idraulica

02.485.00

Dim.: 45 x 65 x 85/120cm

EN Mayo table

S.S.construction.
Variable height
85/120. Casters \varnothing
50 mm. Capacity:
25Kg

FR Table de mayo

En acier inox.
Hauteur réglable
85/120. Roulettes \varnothing
50 mm. Capacité:
25Kg

IT Tavolo Mayo

Acciaio inox.
Altezza variabile
85/120. Ruote
da \varnothing 50 mm.
Capacità: 25Kg



Hydraulic pump
Vérin hydraulique
Pompa idraulica

02.482.00

Dim.: 45 x 65 x 85/120cm

EN Mayo table

S.S.construction.
Variable height
85/120. Casters \varnothing
50 mm. Capacity:
25Kg

FR Table de mayo

En acier inox.
Hauteur réglable
85/120. Roulettes \varnothing
50 mm. Capacité:
25Kg

IT Tavolo Mayo

Acciaio inox.
Altezza variabile
85/120. Ruote
da \varnothing 50 mm.
Capacità: 25Kg



02.523.00

EN Bowl's stand

Stainless steel tube. Variable height 70-123cm. Stainless steel bowl. ø 30 cm. Plastic base 02.522.00 Stainless steel base

FR Porte-cupule

Tube en acier inox. Hauteur 70-123 cm. Cupule en acier inox ø 30 cm. Piètement en plastique. 02.522.00 Piètement en acier inox

IT Porta catino

Tubo d'acciaio inox. Altezza 70-123 cm. Bacinella in acciaio inox ø 30 cm. Base in plastica con ruote. 02.522.00 base in acciaio inox



02.532.00

EN Bowl's stand

Stainless steel tube. Variable height 70-123cm. 2 S.S. bowls. ø 30 cm. S.S. base with castors ø 50 mm. 02.533.00 Plastic base

FR Porte-cupule

Tube en acier inox. Hauteur 70-123 cm. 2 cupules en acier inox ø 30 cm. Piètement en acier inox avec roues ø 50 mm. 02.533.00 Piètement en acier inox

IT Porta catino

Tubo d'acciaio inox. Altezza 70-123 cm. 2 bacinelle in acciaio inox ø 30 cm. Base in inox con ruote ø 50 mm. 02.533.00 base in plastica



02.850.01 / 02.851.01

EN Mounting step

02.850.01 1 step. Stainless steel frame. 38 x 25 x 25,5 H cm
02.851.01 2 steps. Stainless steel frame. 38 x 57 x 43 H cm

FR Marchepied

02.850.01 1 marche. En acier inox. 38 x 25 x 25,5 H cm
02.851.01 2 marches. En acier inox. 38 x 57 x 43 H cm

IT Scalotti

02.850.01 1 scalino. Struttura in acciaio inox. 38 x 25 x 25,5 H cm
02.851.01 2 scalini. Struttura in acciaio inox. 38 x 57 x 43 H cm



02.535.01

Cap.: 3,5 lt.

EN Bowl

Stainless steel 18/10, ø 30 cm.

FR Cuvette

En acier inox 18/10, ø 30 cm.

IT Bacinella

Acciaio inox 18/10, ø 30 cm.



EN Waste bin

Removable plastic inner container.

FR Poubelle

Seau amovible en plastique.

IT Pattumiere

Secchio di plastica removibile.

Epoxy / Époxy / Verniciato
02.411.00 5lt
Stainless steel / Acier inox / Acciaio inox
02.424.00 20lt 02.425.00 12lt



02.551.00

Cap.: 10 lt.

EN Plaster bowl

Stainless steel 18/10.

FR Cupule à plâtre

En acier inox 18/10.

IT Secchio per gesso

Acciaio inox 18/10.

Dim.: ø 28,8 x 25,8H



02.541.00

EN Kick bucket

In S.S. 18/10. 5 casters ø 50 mm with bumpers

FR Bac à déchets

Acier inox 18/10. 5 roulettes ø 50 mm Pare-chocs.

IT Bastardella

Acciaio inox 18/10. 5 ruote da ø 50 mm. Paracolpi.



02.901.00
With gas pump
Avec pompe a gaz
Con pompa a gas
(50 / 70 cm H)

02.900.00

EN Revolving stool

Stainless steel stool. Plastic base with 5 casters ø 50mm.

FR Tabouret tournant

Siège en acier inox. Piètement en plastique avec roulette ø 50mm.

IT Sgabello

Seduta in acciaio inox. Base in plastica con ruote da ø 50mm

Dim.: Seat/Siège/Sedile: 32 cm
Base/Base/Base: 56 cm
Height/Hauteur/Altezza: 48/65cm



02.903.00

EN Padded revolving stool

Plastic base with 5 casters ø 50mm. Variable height by gas pump.

FR Tabouret tournant

Piètement en plastique 5 roulettes ø 50mm. Hauteur variable par pompe a gaz.

IT Sgabello

Base in plastica. 5 ruote da ø 50mm, altezza variabile con pompa a gas.

Dim.: Seat/Siège/Sedile: 34 x 5 H cm
Base/Base/Base: 58 cm
Height/Hauteur/Altezza: 40/55cm

Washable plastic material
Simili-cuir lavable
Similpelle lavabile



02.908.00

EN Padded revolving stool

Plastic base with footrest. 5 casters ø 50mm. Variable height by gas pump.

FR Tabouret tournant

Piètement en plastique avec repose-pieds. 5 roulettes ø 50mm. Hauteur variable par pompe a gaz.

IT Sgabello

Base in plastica con poggiatesta. 5 ruote da ø 50mm. Altezza variabile con pompa a gas.

Dim.: Seat/Siège/Sedile: 35 x 8 H cm
Base/Base/Base: 58 cm
Height/Hauteur/Altezza: 65/85cm

Washable plastic material
Simili-cuir lavable
Similpelle lavabile



02.906.00

EN Padded revolving stool

Plastic base with footrest. 5 casters ø 50mm. Variable height by gas pump.

FR Tabouret tournant

Piètement en plastique avec repose-pieds. 5 roulettes ø 50mm. Hauteur variable par pompe a gaz.

IT Sgabello

Base in plastica con poggiatesta. 5 ruote da ø 50mm. Altezza variabile con pompa a gas.

Dim.: Seat/Siège/Sedile: 38 x 40 x 5 H cm
Base/Base/Base: 58 cm
Height/Hauteur/Altezza: 62/83cm



02.912.00

EN Wood revolving stool

Plastic base with footrest. Variable height by gas pump.

FR Tabouret tournant en bois

Piètement en plastique avec repose-pieds. Hauteur variable par pompe a gaz.

IT Sgabello in legno

Base in plastica con poggiatesta. Altezza variabile con pompa a gas.

Dim.: Seat/Siège/Sedile: 40 x 40 cm
Base/Base/Base: 58 cm
Height/Hauteur/Altezza: 54/80cm



02.907.20

02.907.00

EN Saddle stool

Aluminium base with footrest. 5 casters ø 50mm. Variable height by gas pump.

FR Tabouret selle

Piètement en aluminium avec repose-pieds. Roulettes ø 50mm. Hauteur variable par pompe a gaz.

IT Sgabello a sella

Base in alluminio con poggiatesta. ruote da ø 50mm. Altezza variabile con pompa a gas.

Dim.: Seat/Siège/Sedile: 40 x 8 H cm
Base/Base/Base: 65 cm
Height/Hauteur/Altezza: 63/83cm

air
braccia



GR101

EN Pediatric wheel chair

Chromed steel frame.
Fixed armrest.
Foldable footrest,
solid castors.

FR Fauteuil roulant pour enfant

Tube d'acier chromé.
Accoudoirs fixes.
Repose-pieds escamotables.
Roues pleines.

IT Sedia a rotelle per bambino

Tubo in acciaio cromato. Braccioli fissi. Poggia piedi pieghevoli.
Ruote piene



GR102

EN Wheel chair

Chromed steel frame.
Fixed armrest.
Foldable footrest,
solid castors.

FR Fauteuil roulant

Tube d'acier chromé.
Accoudoirs fixes.
Repose-pieds escamotables.
Roues pleines.

IT Sedia a rotelle

Tubo in acciaio cromato. Braccioli fissi. Poggia piedi pieghevoli.
Ruote piene.



GR103/46

EN Wheel chair

Chromed steel frame.
Seat and backrest in reinforced nylon.
Removable armrest.
Foldable footrest.
Pneumatic wheels.

FR Fauteuil roulant

Tube d'acier chromé.
Siège et dossier en toile nylon. Accoudoirs amovibles, repose-pieds escamotables.
Roues pneumatiques.

IT Sedia a rotelle

Tubo in acciaio cromato. Tessuto in nylon. Braccioli removibili. Poggia piedi pieghevoli.
Ruote pneumatiche.



GR106

EN Wheel chair

Chromed steel frame
Flip-up armrest.
Detachable footrest.
Quick release pneumatic rear wheels, drop back handle.

FR Fauteuil roulant

Tube d'acier chromé.
Accoudoirs amovibles.
Repose-pieds escamotables.
Bouton de déverrouillage rapide.
Roues pneumatiques.

IT Sedia a rotelle

Tubo in acciaio cromato. Braccioli removibili. Poggia piedi pieghevoli.
Pulsante di sgancio rapido. Ruote pneumatiche.

REF.										
GR101	58	20	40	35	49	50	87	100	17,1	
GR102	58	20	40	46	50	63	87	100	17,6	
GR103/46	60	20	40	46	50	65	88	100	17,5	
GR106	61,5	15	40	46	51	64	94	100	15,8	

**GR951****EN** Wheel chair

Epoxy painted steel frame. Quick release button for casters. Flip-up armrest. Detachable footrest. Rubber foam castors, pneumatic mag wheels.

FR Fauteuil roulant

Tube d'acier époxy. Bouton de déverrouillage rapide. Accoudoirs amovibles, repose-pieds escamotables. Roues arrière pneumatiques et roues antérieures pleines.

IT Sedia a rotelle

In acciaio verniciato. Pulsante a sgancio rapido. Bracciali removibili, poggipiedi pieghevoli. Ruote posteriori pneumatiche e ruote anteriori piene.

**GR253****EN** Wheel chair

Aluminium tube, with back pocket. Removable armrests. Retractable footrests. Quick release button for rear casters.

FR Fauteuil roulant

Tube d'aluminium, avec poche arrière. Accoudoirs amovibles. Repose-pieds escamotables. Bouton de déverrouillage rapide pour roulettes arrière.

IT Sedia a rotelle

Tube in alluminio, con tasca posteriore. Bracciali rimovibili. Poggipiedi pieghevoli. Pulsante di sgancio rapido per le ruote posteriori.

**GR107****EN** Wheel chair

Aluminium frame, removable armrest. Detachable footrest, solid castors, quick release wheels, carrying wheels and anti tipers.

FR Fauteuil roulant

Tube d'aluminium, avec poche arrière. Accoudoirs amovibles, Repose-pieds escamotables. Roues avec bouton de déverrouillage rapide.

IT Sedia a rotelle

In alluminio. Con tasca posteriore. Bracciali removibili. Poggia piedi pieghevoli. Ruote pneumatiche pulsante di sgancio rapido.

**GR108****EN** Wheel chair









Aluminium frame. Flip-up armrest. Detachable footrest. Solid castors. Quick release pneumatic rear wheels.

FR Fauteuil roulant

Tube d'aluminium, avec poche arrière. Accoudoirs amovibles. Repose-pieds escamotables. Roues pneumatiques.

IT Sedia a rotelle

In alluminio con tasca posteriore. Bracciali removibili. Poggia piedi pieghevoli. Ruote pneumatiche.

REF.									
GR951	60	20	40	56	54	71	94	125	22,4
GR253	61	15	40	41	51	64	93	100	17,6
GR107	62	15	50	46	50	63	89	100	17,2
GR108	62	20	40	40	52	64	90	100	14,2



GR129

EN Commode chair

Aluminium frame. Removable seat, upholstered and covered with leatherette. Autoclavable bowl under the seat.

FR Fauteuil commode

Châssis en tube d'aluminium. Assise escamotable, rembourrée et lavable. Seau autoclavable sous l'assise.

IT Poltrona comoda

Struttura in alluminio. Seduta rimovibile, imbottita e lavabile. Bacinella autoclavabile sotto il sedile.



GR691

EN Commode chair

Powder coating steel frame. Detachable armrest and footrest. Solid rear castor with lock plastic bowl under the seat.

FR Fauteuil commode

Structure en tube d'acier époxy. Accoudoir et repose-pieds escamotables. Seau autoclavable sous l'assise.

IT Poltrona comoda

Struttura in acciaio verniciato. Seduta rimovibile, imbottita e lavabile. Poggia piedi pieghevoli. Bacinella autoclavabile.



GR128

EN Commode chair

Chromed steel frame. Plastic bowl under the seat. Flip-up armrest and detachable footrest. Solid castors and solid rear wheels.

FR Fauteuil commode

En acier chromé Seau plastique sous le siège. Accoudoirs amovibles, repose-pieds escamotables. Roulettes solides et roues arrière pleines.

IT Poltrona comoda

Struttura in acciaio cromato Bacinella in plastica Bracciuoli removibili, poggia piedi a scomparsa. Ruote piene.



GR105

EN Commode chair









Chromed steel frame. Plastic bowl Reclining high back Detachable armrest Elevating footrest. Rear wheels with integrated brake.

FR Fauteuil commode

En acier chromé Seau plastique sous le siège. Accoudoirs amovibles, repose-pieds escamotables. Roulettes solides et roues arrière pleines.

IT Poltrona comoda

In acciaio cromato. Bacinella in plastica Schienare reclinabile Bracciuoli removibili Poggia piedi a scomparsa. Ruote piene con freno.

REF.									
GR105	58	20	40	44	53	64	129	100	26,1
GR128	58	15	40	45	48	60	93	100	15
GR691	12,5	12,5	55	44	51	44	81	100	12
GR129	-	-	43	43	42/52	46	70/81	100	10,6

**GR104****EN** Wheel chair

Aluminium frame.
Removable armrest.
Detachable
footrest. Quick
release pneumatic
rear wheels.

FR Fauteuil roulant

Tube d'aluminium.
Accoudoirs amovibles.
Repose-pieds
escamotables.
Roues pneumatiques
avec bouton de
déverrouillage.

IT Sedia a rotelle

Struttura in alluminio.
Braccioli removibili.
Poggia piedi
pieghevoli.
Ruote pneumatiche
con pulsante di
sgancio rapido.

**GR804LABJP****EN** Transit wheel chair

Aluminum frame.
Solid mag rear
wheel. Flip-up
Armrest.

FR Fauteuil roulant de transport

En aluminium
Roues arrières
pleines. Accoudoir
relevable.

IT Sedia a rotelle da trasporto

Struttura in
alluminio.
Ruote piene.
Braccioli removibili.

**GR805****EN** Transit wheel chair

Aluminum frame.
Solid mag rear
wheel. Flip-up
Armrest.

FR Fauteuil roulant de transport

En aluminium. Roues
arrières pleines.
Accoudoir relevable.

IT Sedia a rotelle da trasporto

Struttura in
alluminio. Ruote
piene.
Braccioli removibili.

**GR7962L****EN** Shower chair











Aluminium
frame. Seat
and backrest in
plastic material.









FR Fauteuil pour douche

Châssis en tube
d'aluminium. Siège
et dossier en
plastique.

IT Sedia per doccia

Struttura in
alluminio. Seduta
e schienale in
plastica.

REF.										
GR104	31	15	40	46	48	60	90	100	9,5	
GR804LABJP	20	12,5	40	37	45	45	88	100	7,2	
GR805	15	12,5	40	38	45	51	88	100	6,9	

REF.									
GR7962L	75	44	48	39	37	88	100	7,5	



GR200

EN Walking frame foldable
In aluminium with two frontal castors.

FR Déambulateur pliant

En aluminium. Deux roues.

IT Deambulatore pieghevole

Struttura in alluminio con 2 ruote.

Dim.: 49 x 83/98cm



GR202

EN Walking frame foldable
In aluminium with two double castors.

FR Déambulateur pliant

En aluminium. Deux roues.

IT Deambulatore pieghevole

Struttura in alluminio con 2 ruote.

Dim.: 47 x 53 x 82/92cm



GR206

EN Rolling walker
In aluminium with 3 castors and basket.

FR Rollator

En aluminium. 3 roues. Avec panier

IT Deambulatore da passeggio

In alluminio con 3 ruote e cestino

Dim.: 103/123 H cm



GR914

78 x 60 x 92cm

EN Rolling walker

In aluminium with 4 castors and basket.

FR Rollator

En aluminium. 4 roues. Avec panier.

IT Deambulatore da passeggio

In alluminio con 4 ruote e cestino.



GR6401

EN Walking frame

Chrome plated steel tube. Foldable. Adjustable and padded axillary support.

FR Déambulateur

Tube d'acier chromé. Pliant. Gouttières amovibles garnies de mousse et réglables.

IT Deambulatore

Struttura in acciaio cromato pieghevole. Supporto ascellare regolabile e imbottito.

Dim.: 112/140 H cm



GR304

EN Tripod

Aluminium frame. Variable height.

FR Tripode

En aluminium. Hauteur réglable.

IT Tripode

Tubo in alluminio. Altezza regolabile.

Dim.: H 74 - 96 cm



H 88,5cm/118c

GR300

Crutches In aluminium
Canne anglaise en aluminium
Stampella in alluminio



H 86cm/116cm

GR301

Crutches In aluminium
Canne anglaise en aluminium
Stampella in alluminio



H 82cm/92cm

GR302

Walking stick In aluminium
Canne de marche en aluminium
Bastone in alluminio



GR 305
H 94/114cm
GR 306
H 116/136cr
GR 307
H 135/155cr

In aluminium. Height adjustable
En aluminium. Hauteur réglable
In alluminio. Con altezza regolabile

**GR130**

Shower chair in aluminium and plastic
Chaise de douche en aluminium et plastique
Sedia per doccia in alluminio e plastica

**GR811**

Commode chair in epoxy painted steel tube
Siège de toilettes en acier époxy
Sedia comoda in acciaio verniciato

**GR7920L**

Bath stool in epoxy painted steel tube
Tabouret de douche en acier époxy
Sgabello per doccia in acciaio verniciato

**GR131**

Bath stool in aluminium and plastic
Tabouret pour douche en aluminium et plastique
Sgabello per doccia in alluminio e plastica

**GR132**

Bath seat in aluminium and plastic
Planche de bain en aluminium et plastique
Seduta per vasca in alluminio e plastica

**GR133**

Bath seat in aluminium swiveled 360° in 90° steps
Siège en aluminium pivoter à 360° en 90°
Seduta in alluminio ruotabile di 360° in 90°.

**GR250**

40 x 43 x 20cm

Cycle for legs rehabilitation
Pédalier de rééducation des membres inférieurs
Ciclo per rieducazione arti inferiori

**GR9600**

42 x 58,5 x 30,5cm

Cycle for legs rehabilitation
Pédalier de rééducation des membres inférieurs
Ciclo per rieducazione arti inferiori



EN Round steriliser drum
S.Steel 18/10. Sliding removable band and drop down clasps. Hinged lid.

03.1001 mm. Ø 125 x 80 H
03.1002 mm. Ø 125 x 100 H
03.1003 mm. Ø 125 x 125 H
03.1004 mm. Ø 150 x 80 H
03.1005 mm. Ø 150 x 100 H
03.1006 mm. Ø 150 x 130 H
03.1007 mm. Ø 150 x 150 H
03.1008 mm. Ø 150 x 190 H
03.1009 mm. Ø 190 x 125 H
03.1010 mm. Ø 190 x 145 H
03.1011 mm. Ø 190 x 165 H
03.1012 mm. Ø 190 x 190 H
03.1013 mm. Ø 190 x 240 H
03.1014 mm. Ø 190 x 290 H
03.1015 mm. Ø 240 x 120 H

FR Tambour pour stérilisation

En acier inox 18/10. Avec bande amovible coulissante, couvercle à charnières et fermetures latérales.

03.1016 mm. Ø 240 x 145 H
03.1017 mm. Ø 240 x 165 H
03.1018 mm. Ø 240 x 190 H
03.1019 mm. Ø 240 x 240 H
03.1020 mm. Ø 240 x 290 H
03.1021 mm. Ø 240 x 340 H
03.1022 mm. Ø 240 x 390 H
03.1023 mm. Ø 290 x 145 H
03.1024 mm. Ø 290 x 165 H
03.1025 mm. Ø 290 x 190 H
03.1026 mm. Ø 290 x 240 H
03.1027 mm. Ø 290 x 290 H
03.1028 mm. Ø 290 x 340 H
03.1029 mm. Ø 290 x 390 H
03.1030 mm. Ø 340 x 145 H

IT Cestelli per sterilizzare

Acciaio inox 18/10. Coperchio a cerniera e chiusure laterali.

03.1031 mm. Ø 340 x 165 H
03.1032 mm. Ø 340 x 190 H
03.1033 mm. Ø 340 x 240 H
03.1034 mm. Ø 340 x 290 H
03.1035 mm. Ø 340 x 340 H
03.1036 mm. Ø 340 x 390 H
03.1037 mm. Ø 390 x 140 H
03.1038 mm. Ø 390 x 165 H
03.1039 mm. Ø 390 x 190 H
03.1040 mm. Ø 390 x 240 H
03.1041 mm. Ø 390 x 290 H
03.1042 mm. Ø 390 x 340 H
03.1043 mm. Ø 390 x 390 H
03.1044 mm. Ø 390 x 490 H



EN Round steriliser drum
S.Steel 18/10. Hinged lid and side closures. With filter.

03.1051 mm. Ø 125 x 80 H
03.1052 mm. Ø 125 x 100 H
03.1053 mm. Ø 125 x 125 H
03.1055 mm. Ø 150 x 100 H
03.1056 mm. Ø 150 x 130 H
03.1057 mm. Ø 150 x 150 H
03.1058 mm. Ø 150 x 190 H
03.1059 mm. Ø 190 x 145 H
03.1060 mm. Ø 190 x 165 H
03.1061 mm. Ø 190 x 190 H
03.1062 mm. Ø 190 x 240 H
03.1063 mm. Ø 240 x 145 H

FR Tambour pour stérilisation

En acier inox 18/10. Couvercle à charnières et fermetures latérales. Avec filtre.

03.1064 mm. Ø 240 x 165 H
03.1065 mm. Ø 240 x 190 H
03.1066 mm. Ø 240 x 240 H
03.1067 mm. Ø 240 x 290 H
03.1068 mm. Ø 240 x 340 H
03.1069 mm. Ø 240 x 390 H
03.1070 mm. Ø 240 x 145 H
03.1071 mm. Ø 240 x 165 H
03.1072 mm. Ø 240 x 190 H
03.1073 mm. Ø 290 x 240 H
03.1075 mm. Ø 290 x 340 H
03.1076 mm. Ø 290 x 390 H

IT Cestelli per sterilizzare

Acciaio inox 18/10. Coperchio a cerniera e chiusure laterali. Con filtro.

03.1077 mm. Ø 290 x 145 H
03.1078 mm. Ø 290 x 165 H
03.1079 mm. Ø 290 x 190 H
03.1080 mm. Ø 340 x 240 H
03.1081 mm. Ø 340 x 290 H
03.1084 mm. Ø 390 x 140 H
03.1085 mm. Ø 390 x 165 H
03.1086 mm. Ø 390 x 190 H
03.1087 mm. Ø 390 x 240 H
03.1088 mm. Ø 390 x 290 H
03.1089 mm. Ø 390 x 340 H
03.1090 mm. Ø 390 x 390 H



EN Dressing jar
Manufactured in 18/10 S.Steel. With cover.

03.9020.00 mm. 75 x 75
03.9020.10 mm. 100 x 100
03.9020.20 mm. 125 x 125
03.9020.30 mm. 150 x 150

FR Boite à coton

Fabriquée en acier inox 18/10, avec couvercle.

03.9020.40 mm. 180 x 180
03.9020.50 mm. 200 x 200
03.9020.60 mm. 250 x 250
03.9020.70 mm. 300 x 300

IT Vaso porta medicazioni

Fabbricato in acciaio inox 18/10, con coperchio.



EN Instrument box
Manufactured in 18/10 S.S., without welding. With cover.

03.2168 mm. 180 x 80 x 40 H
03.2169 mm. 200 x 100 x 60 H
03.2170 mm. 220 x 120 x 60 H
03.2171 mm. 250 x 120 x 60 H
03.2172 mm. 300 x 150 x 60 H

FR Boite à instruments

Fabriquée en acier inoxydable 18/10, sans soudures. Avec couvercle.

03.2173 mm. 320 x 150 x 60 H
03.2174 mm. 400 x 160 x 75 H
03.2175 mm. 500 x 200 x 120 H
03.2181 mm. 180 x 80 x 40 H
03.2182 mm. 200 x 100 x 60 H

IT Box porta strumenti

Fabbricato in acciaio inox 18/10, senza saldature. Con coperchio.

03.2183 mm. 220 x 120 x 60 H
03.2184 mm. 250 x 120 x 60 H
03.2185 mm. 300 x 150 x 60 H
03.2186 mm. 320 x 150 x 60 H
03.2187 mm. 400 x 160 x 75 H
03.2188 mm. 500 x 200 x 120 H



EN Instrument tray
In 18/10 S.S., two side handles.

FR Plateau a instruments
Acier inox 18/10, deux poignées.

IT Bacinella porta strumenti
Acciaio inox 18/10, 2 maniglie.

03.2135 mm. 210 x 110 x 50
03.2136 mm. 240 x 160 x 50

03.2137 mm. 300 x 180 x 50
03.2138 mm. 360 x 210 x 50
03.2139 mm. 400 x 230 x 55



EN Instrument boiler
In 18/10 S.S., with cover and side handles.

FR Bouilleur a instruments
Acier inox 18/10, avec couvercle et poignées.

IT Bollitore per strumenti
Acciaio inox 18/10, con coperchio e maniglie.

03.2127 mm. 210 x 110 x 50
03.2128 mm. 240 x 160 x 50

03.2129 mm. 365 x 180 x 50
03.2130 mm. 370 x 210 x 50
03.2131 mm. 380 x 230 x 55



EN Irrigator
Manufactured in 18/10 S.S., without welding. With handle.

FR Irrigateur
Fabriquée en acier inox 18/10, sans soudures. Avec poignée.

IT Vassoio per strumenti
Acciaio inox 18/10, senza saldature. Con manico.

03.9001.00 1000 ml
03.9002.10 1500 ml
03.9003.20 2000 ml



EN Graduated jar
Manufactured in 18/10 S.S., without welding. With handle.

FR Verre doseur
Fabriquée en acier inox 18/10, sans soudures. Avec poignée.

IT Caraffa graduata
Acciaio inox 18/10, senza saldature. Con manico.

03.9009 250 ml
03.9010 500 ml
03.9011 1000 ml
03.9012 2000 ml

**EN Round bowl**

In 18/10 S.S., without welding.

FR Cupule

Acier inox 18/10, sans soudures.

IT Bacinella rotonda

Acciaio inox 18/10, senza saldature.

with cover / avec couvercle / con coperchio	03.5256.10 Ø 120 mm ml.450
03.5252.10 Ø 40 mm ml.30	03.5257.10 Ø 150 mm ml.750
03.5253.10 Ø 60 mm ml.50	03.5258.10 Ø 180 mm ml.1500
03.5254.10 Ø 80 mm ml.150	03.5259.10 Ø 200 mm ml.2100
03.5255.10 Ø 100 mm ml.250	03.5260.10 Ø 250 mm ml.3500

**EN Round bowl**

In 18/10 S.S., without welding.

FR Cupule

Acier inox 18/10, sans soudures.

IT Bacinella rotonda

Acciaio inox 18/10, senza saldature.

without cover / sans couvercle / senza coperchio	03.5256.00 Ø 120 mm ml.450
03.5252.00 Ø 40 mm ml.30	03.5257.00 Ø 150 mm ml.750
03.5253.00 Ø 60 mm ml.50	03.5258.00 Ø 180 mm ml.1500
03.5254.00 Ø 80 mm ml.150	03.5259.00 Ø 200 mm ml.2100
03.5255.00 Ø 100 mm ml.250	03.5260.00 Ø 250 mm ml.3500

**EN Kidney bowl**

In 18/10 S.S., without welding.

FR Haricot

Acier inox 18/10, sans soudures.

IT Reniforme

Acciaio inox 18/10, senza saldature.

with cover / avec couvercle / con coperchio	03.5282.10 250 mm ml.550
03.5281.10 160 mm ml.100	03.5283.10 280 mm ml.1000
03.5281.30 200 mm ml.400	03.5283.30 300 mm ml.1500

**EN Kidney bowl**

In 18/10 S.S., without welding.

FR Haricot

Acier inox 18/10, sans soudures.

IT Reniforme

Acciaio inox 18/10, senza saldature.

without cover / sans couvercle / senza coperchio	03.5282.00 250 mm ml.550
03.5281.00 160 mm ml.100	03.5283.00 280 mm ml.1000
03.5281.20 200 mm ml.400	03.5283.20 300 mm ml.1500

**EN Instrument tray**

In 18/10 S.S., without welding.

FR Plateau à instruments

Acier inox 18/10, sans soudures.

IT Vassoio per strumenti

Acciaio inox 18/10, senza saldature.

with cover / avec couvercle / con coperchio	03.5264.10 mm. 320 x 240 x 50
03.5262.10 mm. 220 x 170 x 50	03.5265.10 mm. 370 x 270 x 50
03.5263.10 mm. 280 x 200 x 50	03.5266.10 mm. 460 x 360 x 55

**EN Instrument tray**

In 18/10 S.S., without welding.

FR Plateau à instruments

Acier inox 18/10, sans soudures.

IT Vassoio per strumenti

Acciaio inox 18/10, senza saldature.

without cover / sans couvercle / senza coperchio	03.5264.00 mm. 320 x 240 x 50
03.5262.00 mm. 220 x 170 x 50	03.5265.00 mm. 370 x 270 x 50
03.5263.00 mm. 280 x 200 x 50	03.5266.00 mm. 460 x 360 x 55

**EN Instrument tray**

In 18/10 S.S., without welding.

FR Plateau à instruments

Acier inox 18/10, sans soudures.

IT Vassoio per strumenti

Acciaio inox 18/10, senza saldature.

with cover / avec couvercle / con coperchio	03.5273.10 mm. 300 x 220 x 30
03.5271.10 mm. 220 x 150 x 25	03.5274.10 mm. 350 x 250 x 40
03.5272.10 mm. 260 x 180 x 30	

**EN Instrument tray**

In 18/10 S.S., without welding.

FR Plateau à instruments

Acier inox 18/10, sans soudures.

IT Vassoio per strumenti

Acciaio inox 18/10, senza saldature.

without cover / sans couvercle / senza coperchio	03.5273 mm. 300 x 220 x 30
03.5271 mm. 200 x 150 x 25	03.5274 mm. 350 x 250 x 40
03.5272 mm. 260 x 180 x 30	

**EN Forcep jar**

Manufactured in 18/10 S.S.

FR Porte-pincés

Fabriqué en acier inox 18/10.

IT Porta pinze

Fabbricato in acciaio inox 18/10.

03.7329.00 Ø 30 x 90 mm
03.7329.10 Ø 50 x 130 mm
03.7329.20 Ø 50 x 180 mm

**03.7400****EN Cotton holder**

Manufactured in 18/10 S.S., with inner spring.

FR Pot a coton

Fabriqué en acier inox 18/10. Poussoir intérieur sur ressort.

IT Porta cotone

Fabbricato in acciaio inox 18/10. Con molla interna.

03.7326**EN Sputum cup**

Manufactured in 18/10 S.S., with handle and lid.

FR Crachoir

Fabriqué en acier inox 18/10. Avec couvercle et poignée.

IT Sputacchiera

Fabbricato in acciaio inox 18/10. Con coperchio e maniglia.

**EN Wire basket**

Manufactured in 18/10 S.S.

FR Panier fil

Fabriqué en acier inox 18/10.

IT Contenitori in filo

Fabbricato in acciaio inox 18/10.

03.0001 mm. 210 x 145 x 50
03.0002 mm. 240 x 240 x 50
03.0003 mm. 240 x 240 x 70
03.0004 mm. 240 x 240 x 90
03.0005 mm. 240 x 320 x 50
03.0006 mm. 480 x 240 x 50
03.0007 mm. 540 x 240 x 50
03.0008 mm. 540 x 240 x 70
03.0009 mm. 540 x 240 x 90

**03.8334****EN** Bed pan with cover

Manufactured in 18/10 S.S., without welding. With handle.

FR Bassin de lit avec couvercle

Fabriqu  en acier inox 18/10, sans soudures. Avec poign e.

IT Padella con coperchio

Fabbricato in acciaio inox18/10, senza saldature. Con manico.

03.8335 Without cover / Sans couvercle / Senza coperchio

**EN** Bed pan

Manufactured in 18/10 S.S., without welding. With handle.

FR Bassin de lit

Fabriqu  en acier inox 18/10, sans soudures. Avec poign e.

IT Padella

Fabbricato in acciaio inox18/10, senza saldature. Con manico.

03.8333 Adult / Adulte / Adulto

03.8331 Child / Enfant / Bambino

**50077****EN** Bed pan

Manufactured in plastic with cover. Washable 94 C.

FR Bassin de lit

Fabriqu  en plastique avec couvercle, lavable 94 C.

IT Padella

Fabbricato in plastica con coperchio, lavabile a 94 C.

**EN** Bed pan

Manufactured in 18/10 S.S., without welding.

FR Bassin de lit

Fabriqu  en acier inox 18/10, sans soudures.

IT Padella

Acciaio inox18/10, senza saldature.

03.8336 Adult / Adulte / Adulto

03.8337 Child / Enfant / Bambino

**03.8338****EN** Male urinal

Manufactured in 18/10 S.S., with handle.

FR Urinal homme

Fabriqu  en acier inox 18/10, avec poign e.

IT Pappagallo

Fabbricato in acciaio inox18/10, Con manico.

**50088/1****EN** Male urinal

Manufactured in plastic with cover, washable 94 C. 1000 cl.

FR Urinal homme

Fabriqu  en plastique avec couvercle, lavable 94 C. 1000 cl.

IT Pappagallo

Fabbricato in plastica con coperchio, lavabile a 94 C. 1000 cl.

**03.8338****EN** Female urinal

Manufactured in 18/10 S.S., with handle.

FR Urinal femme

Fabriqu  en acier inox 18/10, avec poign e.

IT Pappagallo femminile

Struttura in acciaio inox 18/10, con maniglia.

**50089/1****EN** Female urinal

Manufactured in plastic with cover, washable 94 C. 1000 cl.

FR Urinal femme

Fabriqu  en plastique avec couvercle, lavable 94 C. 1000 cl.

IT Pappagallo femminile

Struttura in plastica, con coperchio lavaile a 94 C. 1000 cl.

**GR210110C**

Toilet seat raiser
Rehausse wc
Alzawater

Cap. 200 Kg. H 10cm.

**15.9050**

Ice bag
Vessie a glace
Borsa del ghiaccio
Dim.: 25 cm

**15.9051**

Hot water bag
Bouillotte
Borsa dell'acqua calda
Dim.: 2000 ml





HOLDING FRAME WITH FILM VIEWER

Code: DR005

AMPOULES OPENER

Code: DR014

AMPOULES OPENER

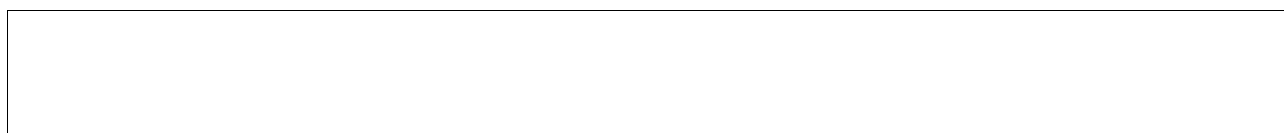



GLOVES HOLDER

Code: DR017



TROLLEY

Code: 02.1050.01

Length: 0.72M

Width: 0.52M

Height: 0.13M

COMPLETE WITH: DRAWER AND S.S. BOWL 18/10 Ø 32 CM.



TROLLEY

Code: 02.1051.01

Length: 0.72M

Width: 0.53M

Height: 0.12M

COMPLETE WITH: DRAWER AND S.S. BOWL 18/10 Ø 32 CM. 2 DRAWERS.



INSTRUMENT TROLLEY

Code: 02.512.00

Length: 0.76M

Width: 0.42M

Height: 0.14M

UTILITY TROLLEY WITH 2 SHELVES



INSTRUMENT TROLLEY

Code: 02.512.10

EPOXY PAINTED KNOCK DOWN FRAME, MOUNTED ON CASTERS. 2 SHELVES.



INSTRUMENT TROLLEY

Code: 02.513.00

Length: 0.86M

Width: 0.48M

Height: 0.14M

UTILITY TROLLEY WITH 3 SHELVES AND GUARD RAIL ON EACH SHELF, CM.46X37X85 H.



INSTRUMENT TROLLEY

Code: 02.513.10

EPOXY PAINTED KNOCK DOWN FRAME, MOUNTED ON CASTERS. 3 SHELVES.



INSTRUMENT TROLLEY

Code: 02.514.00

Length: 1.13M

Width: 0.49M

Height: 0.15M

UTILITY TROLLEY WITH 4 SHELVES, GUARD RAIL ON EACH SHELF, AND ELECTRICAL PLUG.
CM.46X37X112 H.



INSTRUMENT TROLLEY

Code: 02.514.10

Length: 1.08M

Width: 0.51M

Height: 0.21M

EPOXY PAINTED KNOCK DOWN FRAME, MOUNTED ON CASTERS. 4 SHELVES.



INSTRUMENTS TROLLEY

Code: 02.890.00

Length: 0.92M

Width: 0.12M

Height: 0.59M

- 2 flat shelves,
- Castors 2w/brake, 100mm diam.2 antistatic, shelves 1,5mm thick.
- Dimensions: 90 x 50 x 90cm
- With bumpers.
- Dimensions: 90 x 50 x 90cm



INSTRUMENT TROLLEY

Code: 02.895.00

Length: 0.92M

Width: 0.12M

Height: 0.63M

- 2 flat shelves guardrails on 3sides, push handles,100mm diamcastors, 2w/brake and 2 antistatic
- With bumpers.• Shelves 1,5mm thick
- Dimensions: 90 x 55 x 100cm



STORAGE CARTS

Code: 01.7101

Length: 0.47M

Width: 0.82M

Height: 0.41M

MADE OF STAINLESS STEEL GLAZED TUBE AISI 304. EASY TO STERILIZE. EQUIPPED WITH 4 Ø 80 MM. SWIVEL CASTERS, WITH BUMPERS. 100% POLYESTER BAGS, STRONG AND RESISTANT, WITH PRE-STITCHED CLOSING LACE.



SOILED LINEN TROLLEY

Code: 02.842.00

Length: 0.60M

Width: 0.60M

Height: 0.22M

EPOXY PAINTED TUBULAR STEEL. MOUNTED ON Ø 80 MM CASTERS. REMOVABLE BAG.
KNOCK DOWN CONSTRUCTION.



SOILED LINEN TROLLEY

Code: 02.843.00

Length: 0.47M

Width: 0.44M

Height: 0.09M

EPOXY PAINTED TUBULAR STEEL. MOUNTED ON Ø 80 MM CASTERS. REMOVABLE BAG.
KNOCK DOWN CONSTRUCTION.

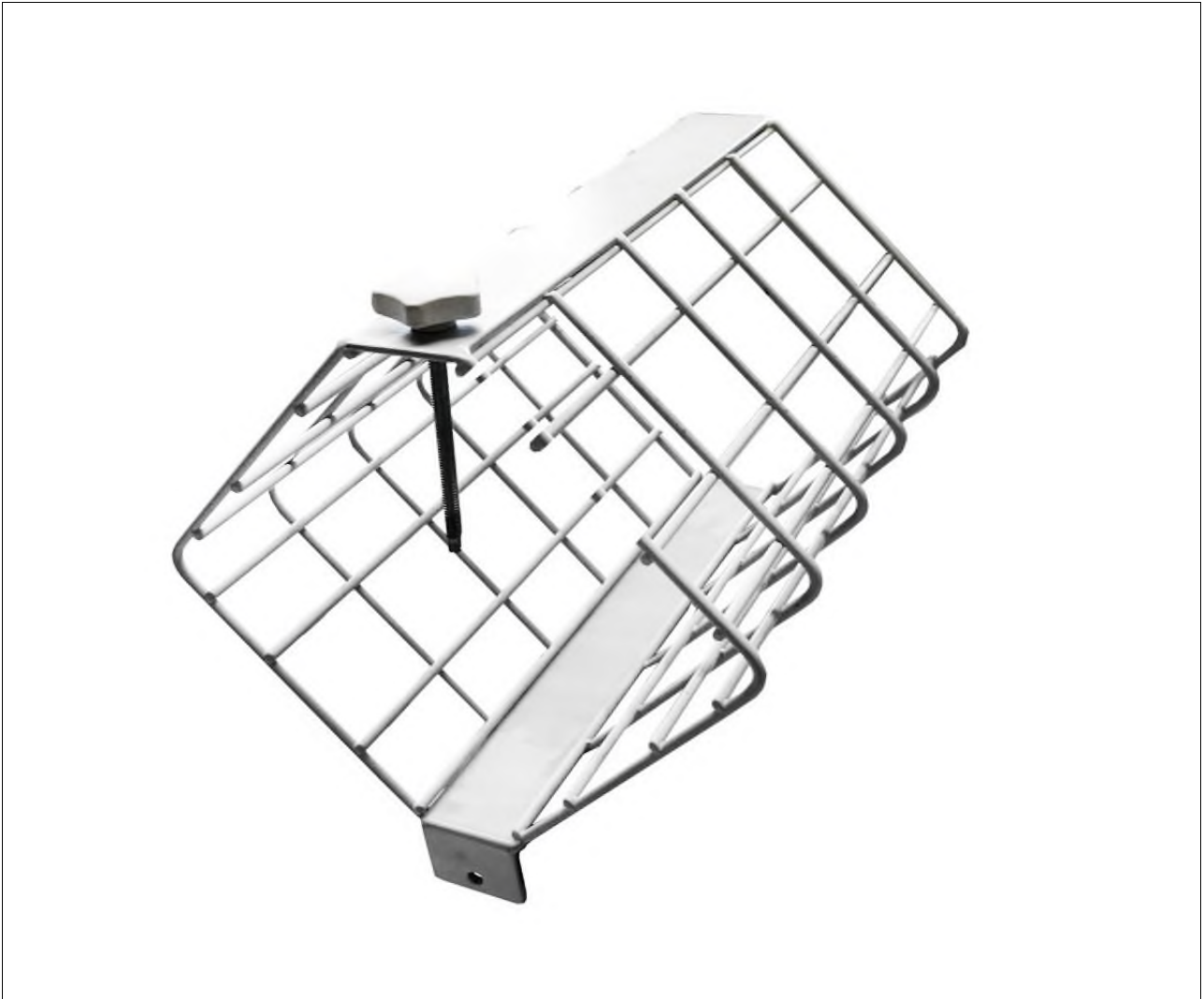

OXYGEN TANK HOLDER FOR PATIENT STRETCHER

Code: C120030.01

Length: 0.31M

Width: 0.16M

Height: 0.16M

OXYGEN TANK HOLDER FOR PATIENT STRETCHER

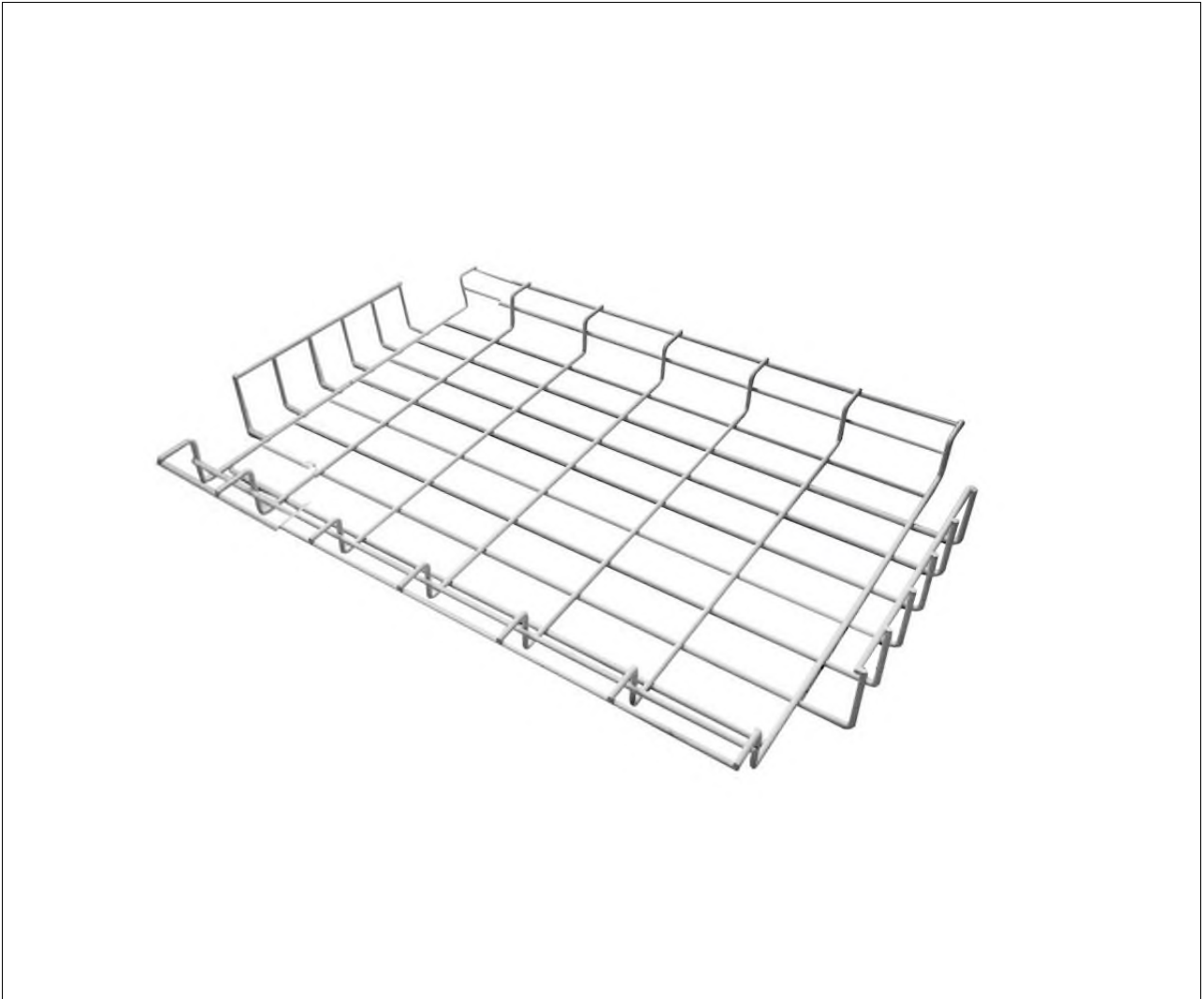

BASKET FOR PATIENT STRETCHER

Code: C120030.05

Length: 2.07M

Width: 0.78M

Height: 0.69M

BASKET FOR PATIENT STRETCHER



PATIENT STRETCHER FIXED TOP

Code: C120033

Length: 1.97M

Width: 0.79M

Height: 0.41M

PATIENT STRETCHER FIXED HEIGHT EPOXY PAINTED STEEL FRAME, PLATFORM FITTED WITH ENAMELLED STEEL WELD MESH. BACK-REST EASILY ADJUSTABLE. MOUNTED ON FOUR Ø 200 MM. CASTERS, TWO OF WHICH WITH BRAKES.

TROLLEY STRETCHER

Code: C120051W/O

Length: 2.00M

Width: 0.68M

Height: 0.20M

TROLLEY STRETCHER REMOVABLE TOP WITHOUT SIDE RAILS AND I.V. STAND

SEDIA CIRCOLARE PER DOCCIA

Code: GR134

SEDIA CIRCOLARE PER DOCCIA



I.V. STAND FOR WHEEL CHAIR

Code: GR50

Length: 0.86M

Width: 0.42M

Height: 0.09M

ACCESSORY APPLICABLE TO WHEELCHAIRS - I.V.STAND



WALKING CANE HOLDER

Code: GR566

ACCESSORY APPLICABLE TO WHEELCHAIRS - I.V.STAND STICK HOLDER



POLYPROPYLENE TOILET SEAT RAISER

Code: GR8141

Length: 0.57M

Width: 0.39M

Height: 0.43M

POLYPROPYLENE TOILET SEAT RAISER WITH TWO LATERAL BRACKETS. MAX CAPACITY 200 KG. HOLE SIZE 25,5 X 21 CM



WALKING FRAME

Code: GR201

Length: 0.60M

Width: 0.18M

Height: 0.82M

WALKING FRAME IN ALUMINIUM, ARTICULATED AND FOLDABLE. H 80/98CM.



WALKING FRAME

Code: GR205

Length: 0.63M

Width: 0.23M

Height: 0.68M

WALKING FRAME IN ALUMINIUM WITH TWO FRONTAL CASTORS, FOLDABLE. H 51/81CM



CRUTCHES

Code: GR300.30

Length: 1.01M

Width: 0.31M

Height: 0.31M

LIGHT ALLOY ELBOW CRUTCH FOAM PADDED HANDLE , BLUE COLOUR ADJUSTABLE CM.

87,5 - 118 PER PIECE



QUAD CANES

Code: GR303

Length: 0.79M

Width: 0.31M

Height: 0.39M

QUAD CANES, ADJUSTABLE HEIGHT CM. 72,5 - 95



CRUTCHES

Code: GR305

Length: 1.00M

Width: 0.33M

Height: 0.30M

ALUMINIUM CRUTCHES UNDERARM ADJUSTABLE. H 103/123CM



CRUTCHES

Code: GR306

Length: 0.34M

Width: 1.20M

Height: 0.30M

ALUMINIUM CRUTCHES UNDERARM ADJUSTABLE. H 116/136CM



CRUTCHES

Code: GR307

Length: 1.41M

Width: 0.34M

Height: 0.30M

ALUMINIUM CRUTCHES UNDERARM ADJUSTABLE. H 128/148CM



WALKING FRAME ON CASTERS 70MM

Code: GR6402

Length: 0.90M

Width: 0.24M

Height: 0.88M

MADE OF EPOXY PAINTED STEEL TUBE. ADJUSTABLE AND PADDED AXILLARY SUPPORT.
ADJUSTABLE HEIGHT. CASTORS Ø 70MM. H 116/146CM



ROLLATOR

Code: GR965

Length: 0.63M

Width: 0.25M

Height: 0.84M

FOUR-WHEELED ROLLATOR WITH BASKET.



ROLLATOR

Code: GR965B

Length: 0.63M

Width: 0.25M

Height: 0.84M

ROLLATOR BLUE COLOUR



ROLLATOR

Code: GR965L

Length: 0.58M

Width: 0.33M

Height: 0.78M

ROLLATOR



WHEEL CHAIR FOLDABLE

Code: GR109

Length: 0.78M

Width: 0.28M

Height: 0.78M

ALUMINIUM FRAME, FLIP-UP ARMREST, DETACHABLE FOOTREST, SOLID CASTORS, PNEUMATIC REAR MAG WHEELS, DROP BACK HANDLE, WITH DRUM BRAKE.



FOLDABLE WHEEL CHAIR

Code: GR903

Length: 0.80M

Width: 0.28M

Height: 0.91M

WHEEL CHAIR

ADULT WHEEL CHAIR FOLDABLE POWDER COATING STEEL FRAME

Code: GR909

Length: 0.82M

Width: 0.28M

Height: 0.93M

ADULT WHEEL CHAIR FOLDABLE

Code: GR953LB

Length: 0.33M

Width: 0.78M

Height: 0.93M

ADULT WHEEL CHAIR FOLDABLE

Code: GR976LABJF2-43

Length: 0.25M

Width: 0.74M

Height: 0.78M



MAYO TABLE

Code: 02.480.01

Length: 0.75M

Width: 0.53M

Height: 0.13M

STAINLESS STEEL CONSTRUCTION, 4 CASTOR 50 MM. VARIABLE HEIGHT FROM 80 TO 115 CM.



MAYO TABLE

Code: 02.483.00

Length: 0.54M

Width: 0.85M

Height: 0.37M

MAYO TABLE WITH MANUAL VARIABLE HEIGHT STAINLESS STEEL STRUCTURE



MAYO TABLE

Code: 02.483.01

Length: 0.54M

Width: 0.85M

Height: 0.37M

MAYO TABLE WITH HYDRAULIC VARIABLE HEIGHT STAINLESS STEEL STRUCTURE

MATTRESS

Code: C110908/2

Length: 1.90M

Width: 0.82M

Height: 0.20M

MATTRESS TWO SECTIONS FOAM D.21 FIXED POLYESTER COVER DIM 70/120X82X12 CM H

MATTRESS

Code: C110909/2

Length: 1.90M

Width: 0.82M

Height: 0.12M

MATTRESS FOAM D.21 REMOVABLE AND WASHABLE COTTON COVER W/ZIP DIMENSIONS
CM 70/120X82X12H

MATTRESS

Code: C110914.10

Length: 0.96M

Width: 0.61M

Height: 0.11M

MATTRESS FOR 01.750.00, D.21, CM.95X60X10 H, WATERPROOF COVER WITH ZIP

BABY MATTRESS

Code: C110919.40

Length: 1.45M

Width: 0.60M

Height: 0.30M

BABY MATTRESS 65X125X12 H FIXED POLYESTER COVER

BABY MATTRESS

Code: C110919.50

Length: 1.45M

Width: 0.60M

Height: 0.30M

BABY MATTRESS D.21, 65X125X12 H WATERPROOF COVER WITH ZIP

MATTRESS

Code: C110920N

Length: 0.67M

Width: 0.37M

Height: 0.37M

MATTRESS FOR 01.800.00, FOAM D.21 FIXED POLYESTER COVER CM.63X36X6 H

MATTRESS

Code: C110921B

Length: 0.63M

Width: 0.36M

Height: 0.18M

MATTRESS FOR 01.800.00, FOAM D.21 REMOVABLE AND WASHABLE COTTON COVER W/ZIP
CM.66X35X6 H

MATTRESS FOR PATIENT STRETCHER

Code: C110923/B

Length: 1.80M

Width: 0.51M

Height: 0.11M

MATTRESS FOR PATIENT STRETCHER C120040, FOAM D.30 REMOVABLE AND WASHABLE
WATER PROOF COVER 74X105X50 10CM H FLAME RETARDANT

MATTRESS PROTECTOR WATERPROOF 190X90 CM

Code: C110929

MATTRESS PROTECTOR WATERPROOF 190X90 CM

PILLOWS

Code: C110973

WATER PROOF REMOVABLE COVER WITH ZIP FOR PILLOW

PILLOWS

Code: C110974

PILLOW COVER FLAME RETARDANT WITH ZIP

COTTON SHEET 215X140 MM

Code: C110990

COTTON SHEET 215X140 MM

COTTON COVER SHEET

Code: C110991

COTTON COVER SHEET

COTTON SHEET FOR C110916

Code: C110992

COTTON SHEET FOR C110916

COTTON COVER FOR C110916

Code: C110993

COTTON COVER FOR C110916



PILLOWS

Code: C110971 CHILD

PILLOW FLAME RETARDANT W/ REMOVABLE COTTON COVER CHILD TYPE



EXAMINATION LAMP WITH MAGNIFYING LENS

Code: 02.740.00

LAMP WITH 3DT BIFOCAL LENS. PROJECTOR WITH MAGNIFYING BICONVEX LENS COMPLETE WITH A 2X9W FLUORESCENT BULB, PROTECTED BY A LIGHT-BREAKING SCREEN. WITH 24V ELECTRONIC FEEDER, CABLE AND PLUG.



LED EXAMINATION LAMP

Code: 02.744.00

Length: 1.12M

Width: 0.14M

Height: 0.59M

LED EXAMINATION LIGHT WITH ADJUSTABLE ARM, SUPPLIED ON PLASTIC BASE WITH 5 CASTORS.



OPERATING LAMP MOVABLE

Code: FLE500BLED

Length: 1.07M

Width: 0.90M

Height: 0.74M

OPERATING LAMP CEILING TYPE DOUBLE 700+500 MM REFLECTORS



WOODEN EXAMINATION COUCH

Code: 02.356.00

Length: 1.95M

Width: 0.81M

Height: 0.19M

WOODEN FRAME, TOP IS UPHOLSTERED AND COVERED WITH WASHABLE PLASTIC MATERIAL FLAME RETARDANT. HEAD REST ADJUSTABLE. COMPLETE WITH PAPER ROLL HOLDER. KNOCK DOWN CONSTRUCTION.



EXAMINATION COUCH

Code: 02.357.10

Length: 180.00CM

Width: 55.00CM

Height: 70.00CM

MANUFACTURED IN EPOXY-PAINTED STEEL TUBE. .FULLY ADJUSTABLE HEADREST. TOP IS UPHOLSTERED AND COVERED WITH WASHABLE PLASTIC AND FLAME RETARDANT MATERIAL. KNOCK DOWN CONSTRUCTION.



EXAMINATION COUCH

Code: 02.358.10

Length: 1.83M

Width: 0.65M

Height: 0.16M

MANUFACTURED IN S.S.FRAME SQUARE STEEL TUBE. FULLY ADJUSTABLE HEADREST. TOP IS UPHOLSTERED AND COVERED WITH WASHABLE PLASTIC AND FLAME RETARDENT MATERIAL. KNOCK DOWN CONSTRUCTION. COMPLETE WITH PAPER ROLL HOLDER.



BLOOD DONOR CHAIR

Code: C150004

Length: 1.92M

Width: 0.67M

Height: 0.18M

BLOOD DONOR CHAIR EPOXY PAINTED STEEL



S.S. STOOL

Code: 02.907.10

Length: 0.47M

Width: 0.47M

Height: 0.74M

STAINLESS STEEL STOOL LARGE BASE. Ø 35CM H 55/65CM



SADDLE STOOL

Code: 02.909.00

Length: 0.59M

Width: 0.11M

Height: 0.56M

SADDLE STOOL



REVOLVING STOOL

Code: 02.910.00

FIVE SPOKE BASE WITH FOOT REST AND ADJUSTABLE HEIGHT. WOODEN SEAT.



INSTRUMENT CABINET

Code: C130306

Length: 1.82M

Width: 0.88M

Height: 0.16M

S.S. INSTRUMENT CABINET 80X40X180H CM



PLASTER BOWL

Code: 02.551.00



WIRE MESH BASKET

Code: 03.0001



WIRE MESH BASKET

Code: 03.0002



WIRE MESH BASKET

Code: 03.0003

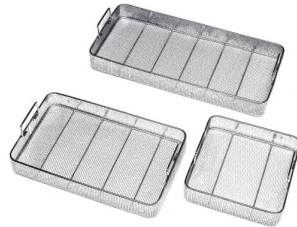

WIRE MESH BASKET

Code: 03.0004

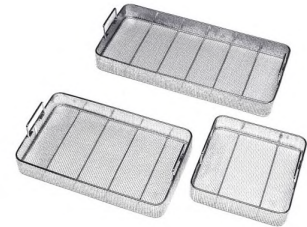

WIRE MESH BASKET

Code: 03.0005



WIRE MESH BASKET

Code: 03.0006



WIRE MESH BASKET

Code: 03.0007



WIRE MESH BASKET

Code: 03.0008



WIRE MESH BASKET

Code: 03.0009



WIRE MESH BASKET

Code: 03.0010



**ROUND STERILISER
DRUM**

Code: 03.1001



**ROUND STERILISER
DRUM**

Code: 03.1002



**ROUND STERILISER
DRUM**

Code: 03.1003



**ROUND STERILISER
DRUM**

Code: 03.1004



**ROUND STERILISER
DRUM**

Code: 03.1005



**ROUND STERILISER
DRUM**

Code: 03.1006



**ROUND STERILISER
DRUM**

Code: 03.1007



**ROUND STERILISER
DRUM**

Code: 03.1008



**ROUND STERILISER
DRUM**

Code: 03.1009



**ROUND STERILISER
DRUM**

Code: 03.1010



**ROUND STERILISER
DRUM**

Code: 03.1011



**ROUND STERILISER
DRUM**

Code: 03.1012



**ROUND STERILISER
DRUM**

Code: 03.1013



**ROUND STERILISER
DRUM**

Code: 03.1014



**ROUND STERILISER
DRUM**

Code: 03.1015



**ROUND STERILISER
DRUM**

Code: 03.1016



**ROUND STERILISER
DRUM**

Code: 03.1017



**ROUND STERILISER
DRUM**

Code: 03.1018



**ROUND STERILISER
DRUM**

Code: 03.1019



**ROUND STERILISER
DRUM**

Code: 03.1020



**ROUND STERILISER
DRUM**

Code: 03.1021



**ROUND STERILISER
DRUM**

Code: 03.1022



**ROUND STERILISER
DRUM**

Code: 03.1023



**ROUND STERILISER
DRUM**

Code: 03.1024



**ROUND STERILISER
DRUM**

Code: 03.1025



**ROUND STERILISER
DRUM**

Code: 03.1026



**ROUND STERILISER
DRUM**

Code: 03.1027



**ROUND STERILISER
DRUM**

Code: 03.1028



**ROUND STERILISER
DRUM**

Code: 03.1029



**ROUND STERILISER
DRUM**

Code: 03.1030



**ROUND STERILISER
DRUM**

Code: 03.1031



**ROUND STERILISER
DRUM**

Code: 03.1032



**ROUND STERILISER
DRUM**

Code: 03.1033



**ROUND STERILISER
DRUM**

Code: 03.1034



**ROUND STERILISER
DRUM**

Code: 03.1035



**ROUND STERILISER
DRUM**

Code: 03.1037



**ROUND STERILISER
DRUM**

Code: 03.1038



**ROUND STERILISER
DRUM**

Code: 03.1039



**ROUND STERILISER
DRUM**

Code: 03.1040



**ROUND STERILISER
DRUM**

Code: 03.1041



**ROUND STERILISER
DRUM**

Code: 03.1042



**ROUND STERILISER
DRUM**

Code: 03.1043



**ROUND STERILISER
DRUM**

Code: 03.1044



**ROUND STERILIZER
DRUMS FILTER**

Code: 03.1051



**ROUND STERILIZER
DRUMS FILTER**

Code: 03.1052



**ROUND STERILIZER
DRUMS FILTER**

Code: 03.1053



**ROUND STERILIZER
DRUMS FILTER**

Code: 03.1055



**ROUND STERILIZER
DRUMS FILTER**

Code: 03.1056



**ROUND STERILIZER
DRUMS FILTER**

Code: 03.1057



**ROUND STERILIZER
DRUMS FILTER**

Code: 03.1058



**ROUND STERILIZER
DRUMS FILTER**

Code: 03.1059



**ROUND STERILIZER
DRUMS FILTER**

Code: 03.1060



**ROUND STERILIZER
DRUMS FILTER**

Code: 03.1061



**ROUND STERILIZER
DRUMS FILTER**

Code: 03.1062



**ROUND STERILIZER
DRUMS FILTER**

Code: 03.1063



**ROUND STERILIZER
DRUMS FILTER**

Code: 03.1064



**ROUND STERILIZER
DRUMS FILTER**

Code: 03.1065



**ROUND STERILIZER
DRUMS FILTER**

Code: 03.1066



**ROUND STERILIZER
DRUMS FILTER**

Code: 03.1067



**ROUND STERILIZER
DRUMS FILTER**

Code: 03.1068



**ROUND STERILIZER
DRUMS FILTER**

Code: 03.1069



**ROUND STERILIZER
DRUMS FILTER**

Code: 03.1070



**ROUND STERILIZER
DRUMS FILTER**

Code: 03.1071



**ROUND STERILIZER
DRUMS FILTER**

Code: 03.1072



**ROUND STERILIZER
DRUMS FILTER**

Code: 03.1073



**ROUND STERILIZER
DRUMS FILTER**

Code: 03.1074



**ROUND STERILIZER
DRUMS FILTER**

Code: 03.1075



**ROUND STERILIZER
DRUMS FILTER**

Code: 03.1076



**ROUND STERILIZER
DRUMS FILTER**

Code: 03.1077



**ROUND STERILIZER
DRUMS FILTER**

Code: 03.1078



**ROUND STERILIZER
DRUMS FILTER**

Code: 03.1079



**ROUND STERILIZER
DRUMS FILTER**

Code: 03.1080



**ROUND STERILIZER
DRUMS FILTER**

Code: 03.1081



**ROUND STERILIZER
DRUMS FILTER**

Code: 03.1084



**ROUND STERILIZER
DRUMS FILTER**

Code: 03.1085



**ROUND STERILIZER
DRUMS FILTER**

Code: 03.1086



**ROUND STERILIZER
DRUMS FILTER**

Code: 03.1087



**ROUND STERILIZER
DRUMS FILTER**

Code: 03.1088



**ROUND STERILIZER
DRUMS FILTER**

Code: 03.1089



**ROUND STERILIZER
DRUMS FILTER**

Code: 03.1090



**INSTRUMENT
TRAYS**

Code: 03.2135



**INSTRUMENT
TRAYS**

Code: 03.2136



**INSTRUMENT
TRAYS**

Code: 03.2137



**INSTRUMENT
TRAYS**

Code: 03.2138



**INSTRUMENT
TRAYS**

Code: 03.2139



**INSTRUMENT
BOILERS**

Code: 03.2168



**INSTRUMENT
BOILERS**

Code: 03.2169



**INSTRUMENT
BOILERS**

Code: 03.2173



**INSTRUMENT
BOXES**

Code: 03.2181



**INSTRUMENT
BOXES**

Code: 03.2182



**INSTRUMENT
BOXES**

Code: 03.2183



**INSTRUMENT
BOXES**

Code: 03.2184



**INSTRUMENT
BOXES**

Code: 03.2185



**INSTRUMENT
BOXES**

Code: 03.2186



**INSTRUMENT
BOXES**

Code: 03.2187



**INSTRUMENT
BOXES**

Code: 03.2188



**INSTRUMENT
BOILERS WITH
SUPPORT**

Code: 03.2191



**INSTRUMENT
BOILERS WITH
SUPPORT**

Code: 03.2192



**INSTRUMENT
BOILERS WITH
SUPPORT**

Code: 03.2193



**INSTRUMENT
BOILERS WITH
SUPPORT**

Code: 03.2194



**INSTRUMENT
BOILERS WITH
SUPPORT**

Code: 03.2195



**INSTRUMENT
BOILERS WITH
SUPPORT**

Code: 03.2196



**INSTRUMENT
BOILERS WITH
SUPPORT**

Code: 03.2197



**INSTRUMENT
BOILERS WITH
SUPPORT**

Code: 03.2198



ALCOHOL PLATE

Code: 03.2201



ALCOHOL PLATE

Code: 03.2202



**ELECTRIC
STERILIZER**

Code: 03.2500.00

**ELECTRIC
STERILIZER**

Code: 03.2501.00

**ELECTRIC
STERILIZER**

Code: 03.2502.00

**ELECTRIC
STERILIZER**

Code: 03.2503.00

**ELECTRIC
STERILIZER**

Code: 03.2504.00

**ELECTRIC
STERILIZER**

Code: 03.2505.00



ROUND BOWLS

Code: 03.5252.00

**COVER FOR ROUND
BOWL**

Code: 03.5252.05



**ROUND BOWLS
WITH COVER**

Code: 03.5252.10



ROUND BOWLS

Code: 03.5253.00

**COVER FOR ROUND
BOWL**

Code: 03.5253.05



**ROUND BOWLS
WITH COVER**

Code: 03.5253.10



ROUND BOWLS

Code: 03.5254.00

**COVER FOR ROUND
BOWL**

Code: 03.5254.05



**ROUND BOWLS
WITH COVER**

Code: 03.5254.10



ROUND BOWLS

Code: 03.5255.00

**COVER FOR ROUND
BOWL**

Code: 03.5255.05



**ROUND BOWLS
WITH COVER**

Code: 03.5255.10



ROUND BOWLS

Code: 03.5256.00

**COVER FOR ROUND
BOWL**

Code: 03.5256.05



**ROUND BOWLS
WITH COVER**

Code: 03.5256.10



ROUND BOWLS

Code: 03.5257.00

**COVER FOR ROUND
BOWL**

Code: 03.5257.05



**ROUND BOWLS
WITH COVER**

Code: 03.5257.10



ROUND BOWLS
Code: 03.5258.00

**COVER FOR ROUND
BOWL**

Code: 03.5258.05



**ROUND BOWLS
WITH COVER**

Code: 03.5258.10



ROUND BOWLS
Code: 03.5259.00

**COVER FOR ROUND
BOWL**

Code: 03.5259.05



**ROUND BOWLS
WITH COVER**

Code: 03.5259.10



ROUND BOWLS
Code: 03.5260.00

**COVER FOR ROUND
BOWL**

Code: 03.5260.05



**ROUND BOWLS
WITH COVER**

Code: 03.5260.10



**INSTRUMENT
TRAYS**

Code: 03.5262.00

**COVER FOR
INSTR.TRAYS**

Code: 03.5262.05



**INSTRUMENT
TRAYS WITH COVER**

Code: 03.5262.10



**INSTRUMENT
TRAYS**

Code: 03.5263.00

**COVER FOR
INSTR.TRAYS**

Code: 03.5263.05



**INSTRUMENT
TRAYS WITH COVER**

Code: 03.5263.10



**INSTRUMENT
TRAYS**

Code: 03.5264.00

**COVER FOR
INSTR.TRAYS**

Code: 03.5264.05



**INSTRUMENT
TRAYS WITH COVER**

Code: 03.5264.10



**INSTRUMENT
TRAYS**

Code: 03.5265.00

**COVER FOR
INSTR.TRAYS**

Code: 03.5265.05



**INSTRUMENT
TRAYS WITH COVER**

Code: 03.5265.10



**INSTRUMENT
TRAYS**

Code: 03.5266.00

**COVER FOR
INSTR.TRAYS**

Code: 03.5266.05



**INSTRUMENT
TRAYS WITH COVER**

Code: 03.5266.10



**INSTRUMENT
TRAYS**

Code: 03.5271

**COVER FOR
INSTR.TRAYS**

Code: 03.5271.05



**INSTRUMENT
TRAYS WITH COVER**

Code: 03.5271.10



**INSTRUMENT
TRAYS**

Code: 03.5272

**COVER FOR
INSTR.TRAYS**

Code: 03.5272.05



**INSTRUMENT
TRAYS WITH COVER**

Code: 03.5272.10



**INSTRUMENT
TRAYS**

Code: 03.5273

**COVER FOR
INSTR.TRAYS**

Code: 03.5273.05



**INSTRUMENT
TRAYS WITH COVER**

Code: 03.5273.10



**INSTRUMENT
TRAYS**

Code: 03.5274

**COVER FOR
INSTR.TRAYS**

Code: 03.5274.05



**INSTRUMENT
TRAYS WITH COVER**

Code: 03.5274.10



KIDNEY BOWLS

Code: 03.5281.00

**COVER FOR KIDNEY
BOWLS**

Code: 03.5281.05



**KIDNEY BOWLS
WITH COVER**

Code: 03.5281.10



KIDNEY BOWLS

Code: 03.5281.20

**COVER FOR KIDNEY
BOWLS**

Code: 03.5281.25



**KIDNEY BOWLS
WITH COVER**

Code: 03.5281.30



KIDNEY BOWLS
Code: 03.5282.00

**COVER FOR KIDNEY
BOWLS**

Code: 03.5282.05



**KIDNEY BOWLS
WITH COVER**

Code: 03.5282.10



KIDNEY BOWLS
Code: 03.5283.00

**COVER FOR KIDNEY
BOWLS**

Code: 03.5283.05



**KIDNEY BOWLS
WITH COVER**

Code: 03.5283.10



KIDNEY BOWLS
Code: 03.5283.20

**COVER FOR KIDNEY
BOWLS**

Code: 03.5283.25



KIDNEY BOWLS
Code: 03.5283.30



SPUTUM CUP

Code: 03.7326



FORCEP JARS

Code: 03.7329.00



FORCEP JARS

Code: 03.7329.10



FORCEP JARS

Code: 03.7329.20



COTTON HOLDER

Code: 03.7400



BED PAN

Code: 03.8331



BED PAN

Code: 03.8333



BED PAN

Code: 03.8334

**COVER FOR BED
PAN ROUND**

Code: 03.8334.05



BED PAN
Code: 03.8335



BED PAN
"FRACTURE" TYPE
Code: 03.8336



BED PAN
"FRACTURE" TYPE
Code: 03.8337



MALE URINAL
Code: 03.8338



FEMALE URINAL
Code: 03.8339



IRRIGATOR
Code: 03.9001.00



IRRIGATOR
Code: 03.9002.10



IRRIGATOR
Code: 03.9003.20



GRADUATED
MEASURING JAR
Code: 03.9008



**GRADUATED
MEASURING JAR**

Code: 03.9009



**GRADUATED
MEASURING JAR**

Code: 03.9010



**GRADUATED
MEASURING JAR**

Code: 03.9011



DRESSING JAR

Code: 03.9012



DRESSING JAR

Code: 03.9020.00



DRESSING JAR

Code: 03.9020.10



DRESSING JAR

Code: 03.9020.20



DRESSING JAR

Code: 03.9020.30



DRESSING JAR

Code: 03.9020.40



DRESSING JAR

Code: 03.9020.50



DRESSING JAR

Code: 03.9020.60



DRESSING JAR

Code: 03.9020.70



WIRE BASKET

Code: F2-1500



WIRE BASKET

Code: F2-1501



WIRE BASKET

Code: F2-1502



WIRE BASKET

Code: F2-1503



WIRE BASKET

Code: F2-450



WIRE BASKET

Code: F2-451



WIRE BASKET

Code: F2-452



WIRE BASKET

Code: F2-453



WIRE BASKET

Code: F2-460



WIRE BASKET

Code: F2-461



WIRE BASKET

Code: F2-462



WIRE BASKET

Code: F2-463



WIRE BASKET

Code: F2-490



WIRE BASKET

Code: F2-491



WIRE BASKET

Code: F2-492



WIRE BASKET

Code: F2-493



SILICON MAT

Code: F2-520



SILICON MAT

Code: F2-521



SILICON MAT

Code: F2-523



SILICON MAT

Code: F2-524



SILICON MAT

Code: F2-525



SILICON MAT

Code: F2-526

**SECURITY PLASTIC
SEAL, BOX OF 100
PCS**

Code: F2-660

**SECURITY PLASTIC
SEAL**

Code: F2-661

**LABELS PAPER FOR
FULL AND HALF
SIZE CONTAINERS**

Code: F2-672

**LABELS PAPER FOR
SMALL SIZE
CONTAINERS**

Code: F2-673

**RED
IDENTIFICATION
LABEL, ENGRAVED
TO YOUR
SPECIFICATIONS, 16
LETTERS MAXIMUM**

Code: F2-700

**BLUE
IDENTIFICATION
LABEL, ENGRAVED
TO YOUR
SPECIFICATIONS, 16
LETTERS MAXIMUM**

Code: F2-701

**GREEN
IDENTIFICATION
LABEL, ENGRAVED
TO YOUR
SPECIFICATIONS, 16
LETTERS MAXIMUM**

Code: F2-702

**YELLOW
IDENTIFICATION
LABEL, ENGRAVED
TO YOUR
SPECIFICATIONS, 16
LETTERS MAXIMUM**

Code: F2-703

**WHITE
IDENTIFICATION
LABEL, ENGRAVED
TO YOUR
SPECIFICATIONS, 16
LETTERS MAXIMUM**

Code: F2-704

**FILTER RETAINER
FOR DISPOSABLE
PAPER FILTER**

Code: F2-720

**SINGLE USE PAPER
FILTER BOX OF 100
PCS - WITH
INDICATOR -
DIAMETER 184 MM.**

Code: F2-741

**TEFLON FILTER REF.
K2-742 FOR 1/1, 3/4,
1/2**

Code: F2-742

**TEFLON FILTER FOR
DENTAL
CONTAINERS DIA
194 MM (2000
CYCLE)**

Code: F2-743

**LONG TERM
TEXTILE FILTER -
SINGLE, ROUND
SHAPE**

Code: F2-751

**SINGLE USE PAPER
FILTER BOX OF 100
PCS - WITH
INDICATOR -
DIMENSION
MM.230X120**

Code: F2-761

WIRE BASKET

Code: F3-1070

WIRE BASKET

Code: F3-1073

**SINGLE USE PAPER
FILTER BOX OF 100
PCS**

Code: F3-612

**SINGLE USE PAPER
FILTER BOX OF 100
PCS**

Code: F3-615

**LONG TERM
TEXTILE FILTER FOR
F6-800/F6-806
(DENTAL), SINGLE
PIECE,
RECTANGULAR
SHAPE, NO
MARKING.**

Code: F3-616

**SPARE SILICONE
GASKET FOR
F6-900/F6-912**

Code: F3-950

**SPARE SILICONE
GASKET FOR
F6-812/F6-806
/F6-800**

Code: F3-951

**SPARE SILICONE
GASKET FRO
F6-500/F6-016**

Code: F3-953

**SPARE SILICONE
GASKET FOR
F6-240/F6-246
/F6-350**

Code: F3-954

**SPARE SILICONE
GASKET FRO F6-010**

Code: F3-955



**ALLUMINIUM
CONTAINER FILTER**

Code: F6-010



**ALLUMINIUM
CONTAINER FILTER**

Code: F6-011



**ALLUMINIUM
CONTAINER FILTER**

Code: F6-012



**ALLUMINIUM
CONTAINER FILTER**

Code: F6-013



**ALLUMINIUM
CONTAINER FILTER**

Code: F6-014



**ALLUMINIUM
CONTAINER FILTER**

Code: F6-015



**ALLUMINIUM
CONTAINER FILTER**

Code: F6-016



**ALLUMINIUM
CONTAINER FILTER**

Code: F6-017



**ALLUMINIUM
CONTAINER FILTER**

Code: F6-018



**ALLUMINIUM
CONTAINER FILTER**

Code: F6-019



**ALLUMINIUM
CONTAINER FILTER**

Code: F6-020



**ALLUMINIUM
CONTAINER FILTER**

Code: F6-021



**ALLUMINIUM
CONTAINER FILTER**

Code: F6-022



**ALLUMINIUM
CONTAINER FILTER**

Code: F6-023



**ALLUMINIUM
CONTAINER FILTER**

Code: F6-024



**ALLUMINIUM
CONTAINER FILTER**

Code: F6-025



**ALLUMINIUM
CONTAINER FILTER**

Code: F6-026



**ALLUMINIUM
CONTAINER FILTER**

Code: F6-027



**ALLUMINIUM
CONTAINER FILTER**

Code: F6-028

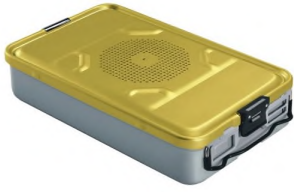

**ALLUMINIUM
CONTAINER FILTER**

Code: F6-029



**ALLUMINIUM
CONTAINER FILTER**

Code: F6-030



**ALLUMINIUM
CONTAINER FILTER**

Code: F6-031



**ALLUMINIUM
CONTAINER FILTER**

Code: F6-032



**ALLUMINIUM
CONTAINER FILTER**

Code: F6-033



**ALLUMINIUM
CONTAINER FILTER**

Code: F6-034



**ALLUMINIUM
CONTAINER FILTER**

Code: F6-035



**ALLUMINIUM
CONTAINER FILTER**

Code: F6-036



**ALLUMINIUM
CONTAINER FILTER**

Code: F6-037



**ALLUMINIUM
CONTAINER FILTER**

Code: F6-038



**ALLUMINIUM
CONTAINER FILTER**

Code: F6-039

**SPARE LID FOR
FILTER**

Code: F6-120

**SPARE LID FOR
FILTER**

Code: F6-121

**SPARE LID FOR
FILTER**

Code: F6-122

**SPARE LID FOR
FILTER**

Code: F6-123

**SPARE LID FOR
FILTER**

Code: F6-124

**SPARE LID FOR
FILTER**

Code: F6-125



**ALLUMINIUM
CONTAINER FILTER**

Code: F6-136

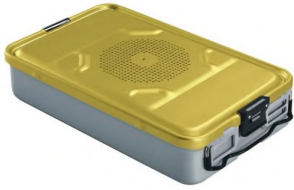

**ALLUMINIUM
CONTAINER FILTER**

Code: F6-137



**ALLUMINIUM
CONTAINER FILTER**

Code: F6-138



**ALLUMINIUM
CONTAINER FILTER**

Code: F6-139



**ALLUMINIUM
CONTAINER FILTER**

Code: F6-140



**ALLUMINIUM
CONTAINER FILTER**

Code: F6-141



**ALLUMINIUM
CONTAINER FILTER**

Code: F6-142



**ALLUMINIUM
CONTAINER FILTER**

Code: F6-143



**ALLUMINIUM
CONTAINER FILTER**

Code: F6-144



**ALLUMINIUM
CONTAINER FILTER**

Code: F6-145



**ALLUMINIUM
CONTAINER FILTER**

Code: F6-146



**ALLUMINIUM
CONTAINER FILTER**

Code: F6-147



**SAFETY LID FOR
FILTER**

Code: F6-230



**SAFETY LID FOR
FILTER**

Code: F6-231



**SAFETY LID FOR
FILTER**

Code: F6-232



**SAFETY LID FOR
FILTER**

Code: F6-233



**SAFETY LID FOR
FILTER**

Code: F6-234



**SAFETY LID FOR
FILTER**

Code: F6-235



**ALLUMINIUM
CONTAINER FILTER**

Code: F6-240

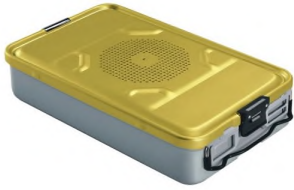

**ALLUMINIUM
CONTAINER FILTER**

Code: F6-241



**ALLUMINIUM
CONTAINER FILTER**

Code: F6-242



**ALLUMINIUM
CONTAINER FILTER**

Code: F6-243



**ALLUMINIUM
CONTAINER FILTER**

Code: F6-244



**ALLUMINIUM
CONTAINER FILTER**

Code: F6-245



**ALLUMINIUM
CONTAINER FILTER**

Code: F6-246



**ALLUMINIUM
CONTAINER FILTER**

Code: F6-247



**ALLUMINIUM
CONTAINER FILTER**

Code: F6-248



**ALLUMINIUM
CONTAINER FILTER**

Code: F6-249

**ALLUMINIUM
CONTAINER FILTER**

Code: F6-250

**ALLUMINIUM
CONTAINER FILTER**

Code: F6-251



**ALLUMINIUM
CONTAINER FILTER**

Code: F6-252



**ALLUMINIUM
CONTAINER FILTER**

Code: F6-253



**ALLUMINIUM
CONTAINER FILTER**

Code: F6-254



**ALLUMINIUM
CONTAINER FILTER**

Code: F6-255

**ALLUMINIUM
CONTAINER FILTER**

Code: F6-256

**ALLUMINIUM
CONTAINER FILTER**

Code: F6-257

**SPARE LID FOR
FILTER**

Code: F6-340

**SPARE LID FOR
FILTER**

Code: F6-341

**SPARE LID FOR
FILTER**

Code: F6-342

**SPARE LID FOR
FILTER**

Code: F6-343

**SPARE LID FOR
FILTER**

Code: F6-344

**SPARE LID FOR
FILTER**

Code: F6-345



**SAFETY LID FOR
FILTER**

Code: F6-410



**SAFETY LID FOR
FILTER**

Code: F6-411



**SAFETY LID FOR
FILTER**

Code: F6-412



**SAFETY LID FOR
FILTER**

Code: F6-413



**SAFETY LID FOR
FILTER**

Code: F6-414



**SAFETY LID FOR
FILTER**

Code: F6-415



**ALLUMINIUM
CONTAINER FILTER**

Code: F6-500



**ALLUMINIUM
CONTAINER FILTER**

Code: F6-501



**ALLUMINIUM
CONTAINER FILTER**

Code: F6-502



**ALLUMINIUM
CONTAINER FILTER**

Code: F6-503



**ALLUMINIUM
CONTAINER FILTER**

Code: F6-504



**ALLUMINIUM
CONTAINER FILTER**

Code: F6-505



**ALLUMINIUM
CONTAINER FILTER**

Code: F6-506

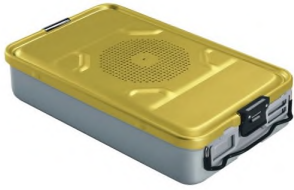

**ALLUMINIUM
CONTAINER FILTER**

Code: F6-507



**ALLUMINIUM
CONTAINER FILTER**

Code: F6-508



**ALLUMINIUM
CONTAINER FILTER**

Code: F6-509



**ALLUMINIUM
CONTAINER FILTER**

Code: F6-510



**ALLUMINIUM
CONTAINER FILTER**

Code: F6-511



**ALLUMINIUM
CONTAINER FILTER**

Code: F6-512



**ALLUMINIUM
CONTAINER FILTER**

Code: F6-513



**ALLUMINIUM
CONTAINER FILTER**

Code: F6-514



**ALLUMINIUM
CONTAINER FILTER**

Code: F6-515



**ALLUMINIUM
CONTAINER FILTER**

Code: F6-516



**ALLUMINIUM
CONTAINER FILTER**

Code: F6-517



**ALLUMINIUM
CONTAINER FILTER**

Code: F6-518



**ALLUMINIUM
CONTAINER FILTER**

Code: F6-519



**ALLUMINIUM
CONTAINER FILTER**

Code: F6-520



**ALLUMINIUM
CONTAINER FILTER**

Code: F6-521



**ALLUMINIUM
CONTAINER FILTER**

Code: F6-522



**ALLUMINIUM
CONTAINER FILTER**

Code: F6-523



**ALLUMINIUM
CONTAINER FILTER**

Code: F6-524



**ALLUMINIUM
CONTAINER FILTER**

Code: F6-525



**ALLUMINIUM
CONTAINER FILTER**

Code: F6-526



**ALLUMINIUM
CONTAINER FILTER**

Code: F6-527



**ALLUMINIUM
CONTAINER FILTER**

Code: F6-528



**ALLUMINIUM
CONTAINER FILTER**

Code: F6-529

**SPARE LID FOR
FILTER**

Code: F6-630

**SPARE LID FOR
FILTER**

Code: F6-631

**SPARE LID FOR
FILTER**

Code: F6-632

**SPARE LID FOR
FILTER**

Code: F6-633

**SPARE LID FOR
FILTER**

Code: F6-634

**SPARE LID FOR
FILTER**

Code: F6-635



**SAFETY LID FOR
FILTER**

Code: F6-700



**SAFETY LID FOR
FILTER**

Code: F6-701



**SAFETY LID FOR
FILTER**

Code: F6-702



**SAFETY LID FOR
FILTER**

Code: F6-703



**SAFETY LID FOR
FILTER**

Code: F6-704



**SAFETY LID FOR
FILTER**

Code: F6-705

**ALLUMINIUM
CONTAINER
DENTAL TYPE**

Code: F6-812



**ALLUMINIUM
CONTAINER
BARRIER**

Code: F7-010



**ALLUMINIUM
CONTAINER
BARRIER**

Code: F7-011



**ALLUMINIUM
CONTAINER
BARRIER**

Code: F7-012



**ALLUMINIUM
CONTAINER
BARRIER**

Code: F7-013



**ALLUMINIUM
CONTAINER
BARRIER**

Code: F7-014



**ALLUMINIUM
CONTAINER
BARRIER**

Code: F7-015



**ALLUMINIUM
CONTAINER
BARRIER**

Code: F7-016



**ALLUMINIUM
CONTAINER
BARRIER**

Code: F7-017



**ALLUMINIUM
CONTAINER
BARRIER**

Code: F7-018



**ALLUMINIUM
CONTAINER
BARRIER**

Code: F7-019



**ALLUMINIUM
CONTAINER
BARRIER**

Code: F7-020



**ALLUMINIUM
CONTAINER
BARRIER**

Code: F7-021



**ALLUMINIUM
CONTAINER
BARRIER**

Code: F7-022



**ALLUMINIUM
CONTAINER
BARRIER**

Code: F7-023



**ALLUMINIUM
CONTAINER
BARRIER**

Code: F7-024



**ALLUMINIUM
CONTAINER
BARRIER**

Code: F7-025



**ALLUMINIUM
CONTAINER
BARRIER**

Code: F7-026



**ALLUMINIUM
CONTAINER
BARRIER**

Code: F7-027



**ALLUMINIUM
CONTAINER
BARRIER**

Code: F7-028



**ALLUMINIUM
CONTAINER
BARRIER**

Code: F7-029



**ALLUMINIUM
CONTAINER
BARRIER**

Code: F7-030



**ALLUMINIUM
CONTAINER
BARRIER**

Code: F7-031



**ALLUMINIUM
CONTAINER
BARRIER**

Code: F7-032



**ALLUMINIUM
CONTAINER
BARRIER**

Code: F7-033



**ALLUMINIUM
CONTAINER
BARRIER**

Code: F7-034



**ALLUMINIUM
CONTAINER
BARRIER**

Code: F7-035



**ALLUMINIUM
CONTAINER
BARRIER**

Code: F7-036



**ALLUMINIUM
CONTAINER
BARRIER**

Code: F7-037



**ALLUMINIUM
CONTAINER
BARRIER**

Code: F7-038



**ALLUMINIUM
CONTAINER
BARRIER**

Code: F7-039

**SPARE LID FOR
VALVE**

Code: F7-120

**SPARE LID FOR
VALVE**

Code: F7-121

**SPARE LID FOR
VALVE**

Code: F7-122

**SPARE LID FOR
VALVE**

Code: F7-123

**SPARE LID FOR
VALVE**

Code: F7-124

**SPARE LID FOR
VALVE**

Code: F7-125



**ALLUMINIUM
CONTAINER BASIC**

Code: F7-240



**ALLUMINIUM
CONTAINER BASIC**

Code: F7-241



**ALLUMINIUM
CONTAINER BASIC**

Code: F7-242



**ALLUMINIUM
CONTAINER BASIC**

Code: F7-243



**ALLUMINIUM
CONTAINER BASIC**

Code: F7-244



**ALLUMINIUM
CONTAINER BASIC**

Code: F7-245



**ALLUMINIUM
CONTAINER BASIC**

Code: F7-246



**ALLUMINIUM
CONTAINER BASIC**

Code: F7-247



**ALLUMINIUM
CONTAINER BASIC**

Code: F7-248



**ALLUMINIUM
CONTAINER BASIC**

Code: F7-249



**ALLUMINIUM
CONTAINER BASIC**

Code: F7-250



**ALLUMINIUM
CONTAINER BASIC**

Code: F7-251



**ALLUMINIUM
CONTAINER BASIC**

Code: F7-252



**ALLUMINIUM
CONTAINER BASIC**

Code: F7-253



**ALLUMINIUM
CONTAINER BASIC**

Code: F7-254



**ALLUMINIUM
CONTAINER BASIC**

Code: F7-255



**ALLUMINIUM
CONTAINER BASIC**

Code: F7-256



**ALLUMINIUM
CONTAINER BASIC**

Code: F7-257

**SPARE LID FOR
VALVE**

Code: F7-340

**SPARE LID FOR
VALVE**

Code: F7-341

**SPARE LID FOR
VALVE**

Code: F7-342

**SPARE LID FOR
VALVE**

Code: F7-343

**SPARE LID FOR
VALVE**

Code: F7-344

**SPARE LID FOR
VALVE**

Code: F7-345



**SAFETY LID FOR
VALVE**

Code: F7-400



**SAFETY LID FOR
VALVE**

Code: F7-401



**SAFETY LID FOR
VALVE**

Code: F7-402



**SAFETY LID FOR
VALVE**

Code: F7-403



**SAFETY LID FOR
VALVE**

Code: F7-404



**SAFETY LID FOR
VALVE**

Code: F7-405



**SAFETY LID FOR
VALVE**

Code: F7-406



**SAFETY LID FOR
VALVE**

Code: F7-407



**SAFETY LID FOR
VALVE**

Code: F7-408



**SAFETY LID FOR
VALVE**

Code: F7-409



**SAFETY LID FOR
VALVE**

Code: F7-410



**SAFETY LID FOR
VALVE**

Code: F7-411



**SAFETY LID FOR
VALVE**

Code: F7-412



**SAFETY LID FOR
VALVE**

Code: F7-413



**SAFETY LID FOR
VALVE**

Code: F7-414



**SAFETY LID FOR
VALVE**

Code: F7-415



**SAFETY LID FOR
VALVE**

Code: F7-416



**SAFETY LID FOR
VALVE**

Code: F7-417



**SAFETY LID FOR
VALVE**

Code: F7-500



**ALLUMINIUM
CONTAINERS VALVE**

Code: F7-501



**ALLUMINIUM
CONTAINERS VALVE**

Code: F7-502



**ALLUMINIUM
CONTAINERS VALVE**

Code: F7-503



**ALLUMINIUM
CONTAINERS VALVE**

Code: F7-504



**ALLUMINIUM
CONTAINERS VALVE**

Code: F7-505



**ALLUMINIUM
CONTAINERS VALVE**

Code: F7-506



**ALLUMINIUM
CONTAINERS VALVE**

Code: F7-507



**ALLUMINIUM
CONTAINERS VALVE**

Code: F7-508



**ALLUMINIUM
CONTAINERS VALVE**

Code: F7-509



**ALLUMINIUM
CONTAINERS VALVE**

Code: F7-510



**ALLUMINIUM
CONTAINERS VALVE**

Code: F7-511



**ALLUMINIUM
CONTAINERS VALVE**

Code: F7-512



**ALLUMINIUM
CONTAINERS VALVE**

Code: F7-513



**ALLUMINIUM
CONTAINERS VALVE**

Code: F7-514



**ALLUMINIUM
CONTAINERS VALVE**

Code: F7-515



**ALLUMINIUM
CONTAINERS VALVE**

Code: F7-516



**ALLUMINIUM
CONTAINERS VALVE**

Code: F7-517



**ALLUMINIUM
CONTAINERS VALVE**

Code: F7-518



**ALLUMINIUM
CONTAINERS VALVE**

Code: F7-519



**ALLUMINIUM
CONTAINERS VALVE**

Code: F7-520



**ALLUMINIUM
CONTAINERS VALVE**

Code: F7-521



**ALLUMINIUM
CONTAINERS VALVE**

Code: F7-522



**ALLUMINIUM
CONTAINERS VALVE**

Code: F7-523



**ALLUMINIUM
CONTAINERS VALVE**

Code: F7-524



**ALLUMINIUM
CONTAINERS VALVE**

Code: F7-525



**ALLUMINIUM
CONTAINERS VALVE**

Code: F7-526



**ALLUMINIUM
CONTAINERS VALVE**

Code: F7-527



**ALLUMINIUM
CONTAINERS VALVE**

Code: F7-528



**ALLUMINIUM
CONTAINERS VALVE**

Code: F7-529

**SPARE LID FOR
VALVE TYPE**

Code: F7-630

**SPARE LID FOR
VALVE TYPE**

Code: F7-631

**SPARE LID FOR
VALVE TYPE**

Code: F7-632

**SPARE LID FOR
VALVE TYPE**

Code: F7-633

**SPARE LID FOR
VALVE TYPE**

Code: F7-634

**SPARE LID FOR
VALVE TYPE**

Code: F7-635



**ALLUMINIUM
CONTAINERS VALVE**

Code: F7-711



**SPARE LID FOR
VALVE TYPE**

Code: F7-712



**SPARE LID FOR
VALVE TYPE**

Code: F7-713



**SPARE LID FOR
VALVE TYPE**

Code: F7-714



**SPARE LID FOR
VALVE TYPE**

Code: F7-715



**SPARE LID FOR
VALVE TYPE**

Code: F7-716



**SPARE LID FOR
VALVE TYPE**

Code: F7-717



**SPARE LID FOR
VALVE TYPE**

Code: F7-718



**SPARE LID FOR
VALVE TYPE**

Code: F7-719



**SPARE LID FOR
VALVE TYPE**

Code: F7-720



**SPARE LID FOR
VALVE TYPE**

Code: F7-721



**SPARE LID FOR
VALVE TYPE**

Code: F7-722



PATIENT CABINET

Code: C130200.01

Length: 0.45M

Width: 0.53M

Height: 1.90M

PATIENT CABINET 1 DOOR 41.5X50X190H CM. BLUE



PATIENT CABINET

Code: C130210.01

PATIENT CABINET 3 DOORS 120X50X190H CM.BLUE



CHILD COT

Code: 01.752.00

Length: 1.61M

Width: 0.17M

Height: 0.67M

MADE OF EPOXY-PAINTED TUBULAR STEEL TUBE, STEEL MESH PLATFORM. DROP DOWN SIDE RAILS WITH SAFETY CATCHES. MOUNTED ON FOUR Ø 100 MM. CASTERS TWO WITH BRAKES. KNOCK DOWN CONSTRUCTION.



CHILD COT

Code: 01.762.00

Length: 0.17M

Width: 1.62M

Height: 0.65M

MADE OF EPOXY-PAINTED TUBULAR STEEL TUBE, STEEL MESH PLATFORM. DROP DOWN SIDE RAILS WITH SAFETY CATCHES. MOUNTED ON FOUR Ø 100 MM. CASTERS TWO WITH BRAKES. KNOCK DOWN CONSTRUCTION.



CHILD COT

Code: 01.772.00

Length: 1.63M

Width: 0.17M

Height: 0.76M

MADE OF EPOXY-PAINTED TUBULAR STEEL TUBE, STEEL MESH PLATFORM. DROP DOWN SIDE RAILS WITH SAFETY CATCHES. MOUNTED ON FOUR Ø 100 MM. CASTERS TWO WITH BRAKES. KNOCK DOWN CONSTRUCTION.

По вопросам продаж и поддержки обращайтесь:

Алматы (7273)495-231
Ангарск (3955)60-70-56
Архангельск (8182)63-90-72
Астрахань (8512)99-46-04
Барнаул (3852)73-04-60
Белгород (4722)40-23-64
Благовещенск (4162)22-76-07
Брянск (4832)59-03-52
Владивосток (423)249-28-31
Владикавказ (8672)28-90-48
Владимир (4922)49-43-18
Волгоград (844)278-03-48
Вологда (8172)26-41-59
Воронеж (473)204-51-73
Екатеринбург (343)384-55-89
Иваново (4932)77-34-06
Ижевск (3412)26-03-58
Иркутск (395)279-98-46
Казань (843)206-01-48
Россия +7(495)268-04-70

Калининград (4012)72-03-81
Калуга (4842)92-23-67
Кемерово (3842)65-04-62
Киров (8332)68-02-04
Коломна (4966)23-41-49
Кострома (4942)77-07-48
Краснодар (861)203-40-90
Красноярск (391)204-63-61
Курск (4712)77-13-04
Липецк (4742)52-20-81
Магнитогорск (3519)55-03-13
Москва (495)268-04-70
Мурманск (8152)59-64-93
Набережные Челны (8552)20-53-41
Нижний Новгород (831)429-08-12
Новокузнецк (3843)20-46-81
Ноябрьск (3496)41-32-12
Новосибирск (383)227-86-73
Киргизия +996(312)-96-26-47

Омск (3812)21-46-40
Орел (4862)44-53-42
Оренбург (3532)37-68-04
Пенза (8412)22-31-16
Петрозаводск (8142)55-98-37
Псков (8112)59-10-37
Пермь (342)205-81-47
Ростов-на-Дону (863)308-18-15
Рязань (4912)46-61-64
Самара (846)206-03-16
Саранск (8342)22-96-24
Санкт-Петербург (812)309-46-40
Саратов (845)249-38-78
Севастополь (8692)22-31-93
Симферополь (3652)67-13-56
Смоленск (4812)29-41-54
Сочи (862)225-72-31
Ставрополь (8652)20-65-13
Сургут (3462)77-98-35
Казахстан +7(7172)727-132

Сыктывкар (8212)25-95-17
Тамбов (4752)50-40-97
Тверь (4822)63-31-35
Тольятти (8482)63-91-07
Томск (3822)98-41-53
Тула (4872)33-79-87
Тюмень (3452)66-21-18
Ульяновск (8422)24-23-59
Улан-Удэ (3012)59-97-51
Уфа (347)229-48-12
Хабаровск (4212)92-98-04
Чебоксары (8352)28-53-07
Челябинск (351)202-03-61
Череповец (8202)49-02-64
Чита (3022)38-34-83
Якутск (4112)23-90-97
Ярославль (4852)69-52-93