

Технические характеристики

По вопросам продаж и поддержки обращайтесь:

Алматы (7273)495-231	Калининград (4012)72-03-81	Омск (3812)21-46-40	Сыктывкар (8212)25-95-17
Ангарск (3955)60-70-56	Калуга (4842)92-23-67	Орел (4862)44-53-42	Тамбов (4752)50-40-97
Архангельск (8182)63-90-72	Кемерово (3842)65-04-62	Оренбург (3532)37-68-04	Тверь (4822)63-31-35
Астрахань (8512)99-46-04	Киров (8332)68-02-04	Пенза (8412)22-31-16	Тольятти (8482)63-91-07
Барнаул (3852)73-04-60	Коломна (4966)23-41-49	Петрозаводск (8142)55-98-37	Томск (3822)98-41-53
Белгород (4722)40-23-64	Кострома (4942)77-07-48	Псков (8112)59-10-37	Тула (4872)33-79-87
Благовещенск (4162)22-76-07	Краснодар (861)203-40-90	Пермь (342)205-81-47	Тюмень (3452)66-21-18
Брянск (4832)59-03-52	Красноярск (391)204-63-61	Ростов-на-Дону (863)308-18-15	Ульяновск (8422)24-23-59
Владивосток (423)249-28-31	Курск (4712)77-13-04	Рязань (4912)46-61-64	Улан-Удэ (3012)59-97-51
Владикавказ (8672)28-90-48	Курган (3522)50-90-47	Самара (846)206-03-16	Уфа (347)229-48-12
Владимир (4922)49-43-18	Липецк (4742)52-20-81	Саранск (8342)22-96-24	Хабаровск (4212)92-98-04
Волгоград (844)278-03-48	Магнитогорск (3519)55-03-13	Санкт-Петербург (812)309-46-40	Чебоксары (8352)28-53-07
Вологда (8172)26-41-59	Москва (495)268-04-70	Саратов (845)249-38-78	Челябинск (351)202-03-61
Воронеж (473)204-51-73	Мурманск (8152)59-64-93	Севастополь (8692)22-31-93	Череповец (8202)49-02-64
Екатеринбург (343)384-55-89	Набережные Челны (8552)20-53-41	Симферополь (3652)67-13-56	Чита (3022)38-34-83
Иваново (4932)77-34-06	Нижний Новгород (831)429-08-12	Смоленск (4812)29-41-54	Якутск (4112)23-90-97
Ижевск (3412)26-03-58	Новокузнецк (3843)20-46-81	Сочи (862)225-72-31	Ярославль (4852)69-52-93
Иркутск (395)279-98-46	Ноябрьск (3496)41-32-12	Ставрополь (8652)20-65-13	
Казань (843)206-01-48	Новосибирск (383)227-86-73	Сургут (3462)77-98-35	
Россия +7(495)268-04-70	Киргизия +996(312)-96-26-47	Казахстан +7(7172)727-132	



Surgical Instrument Set



■ GENERAL SURGERY / CHIRURGIE GÉNÉRALE

- SET100 Abdominal retractor set / Boîte écarteurs abdominaux
- SET101 Abdominal surgery set / Boîte pour abdomen
- SET102 Alternate abdominal surgery set / Boîte chirurgie parties molles
- SET103 Amputation surgery set / Boîte pour amputation
- SET104 Appendectomy and hernia surgery set / Boîte pour appendicite-hernie
- SET105 Appendectomy set / Boîte appendicectomie
- SET106 Autopsy surgery set / Boîte à autopsie simple
- SET107 Basic surgery set (MSF) / Boîte chirurgie de base
- SET108 Child surgery set / Boîte pour chirurgie de l'enfant
- SET109 Circumcision set / Boîte pour circoncision
- SET110 Complete minor surgery set / Boîte pour chirurgie mineure
- SET111 Digestive and biliar surgical set / Boîte pour chirurgie biliaire et digestive
- SET112 Dressing set / Boîte à pansement
- SET113 Emergency surgery set / Boîte urgence soins
- SET114 Emergency treatment set / Boîte urgence soins
- SET115 Gastro surgery set / Boîte pour estomac
- SET116 Gastrointestinal surgery set / Boîte gastrectomie
- SET117 Hand and tendon surgery set / Boîte chirurgie mains et tendons
- SET118 Hernia set / Boîte pour chirurgie de la hernie
- SET119 Incision and drainage abscess set / Boîte pour abcès-sutures
- SET120 Instrument surgical toilet set / Boîte à compresses
- SET121 Intestinal set / Boîte pour intestin
- SET122 Laparotomy surgery set / Boîte laparotomie
- SET123 Lung surgery set / Boîte chirurgie pulmonaire
- SET124 Major basic surgery set / Boîte grand nécessaire pour chirurgie
- SET125 Micro-surgery set / Boîte pour micro-chirurgie
- SET126 Nurse's instrument set / Boîte pour infirmier
- SET127 Plastic and facial surgery set / Boîte chirurgie plastique maxilo-faciale
- SET128 Prostatectomy surgery set / Boîte pour chirurgie de la prostate
- SET129 Stitch removal microsurgical set / Boîte à dénudation
- SET130 Thoractomy surgery set / Boîte pour chirurgie du thorax
- SET131 Trauma surgery set / Boîte pour traumatologie
- SET132 Wound treatment set / Boîte à pansements

■ BONES / OSSEUSES

- SET300 Bone surgery set / Boîte chirurgie osseuse
- SET301 Plaster set / Boîte pour plâtre
- SET302 Traumatology surgery set / Boîte traumatologie

■ VASCULAR / VASCULAIRE

- SET400 Vascular surgery set / Boîte pour chirurgie vasculaire

INSTRUMENTS SETS

- • The content of each set is available on request or can be downloaded from our website www.fazzini.it as a PDF file.

BOÎTES DE COMPOSITION

- • Le contenu de chaque jeu est disponible sur demande ou peut être téléchargé de notre site www.fazzini.it sous format PDF.



■ GYNECOLOGY AND UROLOGY / GYNÉCOLOGIE ET UROLOGIE

SET200	Caesarean section surgery set / Boîte césarienne
SET201	Complete normal delivery set / Boîte accouchement complète
SET202	Delivery set / Boîte accouchement
SET203	Dilation & Curetage set / Boîte de curetage
SET204	Emergency gynecology set / Boîte urgence gynécologique
SET205	Episiotomy repair set / Boîte de réparation de l'épisiotomie
SET206	Episiotomy set / Boîte épisiotomie
SET207	Gall bladder surgery set / Boîte pour chirurgie de la vésicule
SET208	Hegar dilatation set / Bougies simples de Hégar, Boîte de 30
SET209	Hysterectomy surgery set / Boîte pour hystérectomie
SET210	IUD (sterilet) implantation and removing surgical set / Boîte insertion et enlèvement DIU
SET211	IUD (sterilet) implantation surgical set / Boîte pour pose de stérilet
SET212	IUD (sterilet) removing surgical set / Boîte d'enlèvement de D.I.U.
SET213	Normal basic delivery set / Boîte accouchement simple
SET214	Normal delivery and episiotomy repair set / Boîte accouchement-épisiotomie
SET215	Obstetrical craniotomy set / Boîte de cranioclastie obstétricale
SET216	Obstetrical forceps set / Boîte de forceps
SET217	Perineal plastic surgery set / Boîte à périnée
SET218	Tarnier obstetrical forceps / Boîte forceps de Tarnier
SET219	Urology surgery set / Boîte de chirurgie pour urologie
SET220	Uterine biopsy set / Boîte biopsie utérine
SET221	Vaginal closure-Circlage set / Boîte cerclage du col utérin
SET222	Vaginal examination set / Boîte examen vaginal
SET223	Vaginal exploration set / Boîte exploration vaginale
SET224	Vaginal fistula set / Boîte pour fistules vaginales

■ E.N.T. / O.R.L.

SET500	Adult intubation set / Boîte intubation adulte
SET501	Burr hole surgery set / Boîte pour larynx
SET502	Complete ENT surgery set / Boîte complète pour ORL
SET503	Emergency ENT surgery set / Boîte urgence ORL
SET504	Tonsillectomy surgery set / Boîte pour amygdales
SET505	Tracheostomy + cannulas surgery set / Boîte pour trachéotomie + canules

■ OPHTHALMOLOGY / OPHTALMOLOGIE

SET600	Basic eye surgery set / Boîte chirurgie de base oculaire
SET601	Foreign body removal set / Boîte à corps étrangers

■ DENTAL / DENTAIRE

SET700	Adult dental surgery forceps / Boîte pour dentiste
SET701	Dental instrument set / Boîte pour chirurgie dentaire

INSTRUMENTS SETS

- The content of each set is available on request or can be downloaded from our website www.fazzini.it as a PDF file.

BOÎTES DE COMPOSITION

- Le contenu de chaque jeu est disponible sur demande ou peut être téléchargé de notre site www.fazzini.it sous format PDF.



■ SET 104

APPENDECTOMY AND HERNIA SURGERY SET

CONTENT	Qty
Stainless Steel Bowl 60 mm / 60 ml with spout	1
Stainless Steel Bowl 80 mm / 165 ml with spout	1
Sterilizing Stainless Steel Box 40x20x9 cm	1
Reverdin needle - average curved 20 cm	1
Reverdin needle - average 1/2 Curved 20 cm	1
Mayo Scissors Straight 18 cm	1
Mayo Scissors Curved 18 cm	1
Operating Scissors B/B Straight 16 cm	1
Yankauer Cannula 27 cm	1
Scalpel Handle N°4	1
Farabeuf Retractor 15 cm (pair)	1
Gosset Retractor with 3 blades Adult 22 cm	1
Kocher Forceps 1x2 Teeth Straight 13 cm	4
Kocher Forceps 1x2 Teeth Straight 14 cm	2
Rochester-Pean Forceps Straight no teeth 16 cm	4
Mair Polypus Forceps Straight 24 cm	1
Halstead Forceps Straight 1x2 Teeth 13 cm	6
Halstead Forceps Curved No Teeth 13 cm	6
Ombredanne Forceps 13 cm	1
Backhaus Towel Forceps 14 cm	6
Chaput Forceps 13 cm	2
Terrier Forceps No Teeth 13 cm	2
Tissue Forceps 1x2 Teeth 14 cm	1
Tissue Forceps 1x2 Teeth 20 cm	1
Dissecting Forceps No Teeth 14 cm	1
Mayo-Hegar Needle Holder 14 cm	1
Bengolea Forceps Curved No Teeth 24 cm	2
Probe With Tread 14 cm	1

BOÎTE POUR APPENDICITE-HERNIE

CONTENU	Qty
Cupule en acier inoxydable 60 mm / 60 ml avec bec verseur	1
Cupule en acier inoxydable 80 mm / 165 ml avec bec verseur	1
Boîte en acier inox 40x20x9 cm	1
Aiguille Reverdin - moyenne courbée 20 cm	1
Aiguille Reverdin - moyenne 1/2 courbe 20 cm	1
Ciseaux de Mayo droite 18 cm	1
Ciseaux de Mayo courbe 18 cm	1
Ciseaux opératoires émoussé droit 16 cm	1
Canule de Yankauer 27 cm	1
Manche à bistouri N°4	1
Retracteur de Farabeuf 15 cm (paire)	1
Ecarteur de Gosset à 3 lames adulte 22 cm	1
Pince de Kocher 1x2 A/G droite 13 cm	4
Pince de Kocher 1x2 A/G droite 14 cm	2
Pince de Rochester-Pean Forceps droite S/G 16 cm	4
Pince à polype de Mair droite 24 cm	1
Pince de Halstead droite 1x2 A/G 13 cm	6
Pince de Halstead courbe S/G 13 cm	6
Pince de Ombredanne 13 cm	1
Pince à champs Backhaus 14 cm	6
Pince de Chaput 13 cm	2
Pince de Terrier S/G 13 cm	2
Pince à dissection 1x2 A/G 14 cm	1
Pince à dissection 1x2 A/G 20 cm	1
Pince à dissection S/G 14 cm	1
Porte-aiguille de Mayo-Hegar 14 cm	1
Pince de Bengolea courbe S/G 24 cm	2
Sonde 14 cm	1

■ SET 110

COMPLETE MINOR SURGERY SET

CONTENT	Qty
Sterilizing Stainless Steel Box 25x10x5 cm	1
Mayo Scissors Straight 16 cm	1
Mayo Scissors Curved 16 cm	1
Scalpel Handle N°4	1
Farabeuf Retractor 15 cm (pair)	1
Halstead Forceps Straight 1x2 Teeth 13 cm	4
Halstead Forceps Curved No Teeth 13 cm	4
Backhaus Towel Forceps 12 cm	4
Murphy-Pean Forceps Straight 14 cm	1
Tissue Forceps 1x2 Teeth 14 cm	1
Dissecting Forceps No Teeth 14 cm	1
Mayo-Hegar Needle Holder 16 cm	1
Mixer-O'Shaughnessy Artery Forceps 90° 14 cm baby	1
Director and Tongue tie 14 cm	1
Probe With Tread 14 cm	1

BOÎTE POUR CHIRURGIE MINEURE

CONTENU	Qty
Boîte inox 25x10x5 cm	1
Ciseaux Mayo Droits 16 cm	1
Ciseaux Mayo Courbes 16 cm	1
Manche bistouri N°4	1
Ecarteur Farabeuf 15 cm x 16 mm (la paire)	1
Pince Halstead 13cm droite A/G	4
Pince Halstead 13cm courbe S/G	4
Pince à champs Backhaus 12 cm	4
Forceps Pèan Murphy 14 cm	1
Pince à dissection A/G 14 cm	1
Pince à dissection S/G 14 cm	1
Porte-aiguille Mayo-Hegar 16 cm	1
Pince Mixer-O'Shaughnessy 90° 14 cm baby	1
Sonde cannelée 14 cm	1
Stylet porte-coton 14 cm	1

- The content of each set is available on request or can be downloaded from our website www.fazzini.it as a PDF file.
- The content is indicative and some dimensions may change without prior notice without affecting the intended use.



■ SET 112

DRESSING SET

CONTENT	Qty
Lister Bandage scissors 14cm	1
Deaver operating scissors straight B/B 14cm	1
Standard tissue forceps 14,5cm straight 1x2 teeth	1
Thumb and tissue forceps 14,5cm	1
Pean Hemostatic forceps delicate model straight 14cm	1
Doyen channeled director 14cm	1
Instrument box 18x8x4 cm	1

BOÎTE À PANSEMENT

CONTENU	Qty
Ciseaux de Lister pour bandage 14cm	1
Ciseaux opératoires Deaver droits émoussé 14cm	1
Pince à dissection 1x2 A/G 14 cm	1
Pince à dissection S/G 14 cm	1
Pince hémostatique de Pean modèle délicate droite 14cm	1
Sonde cannellée de Doyen 14cm	1
Boite à instruments 18x8x4 cm	1

■ SET 119

INCISION AND DRAINAGE ABCESS SET

CONTENT	Qty
Sterilizing Stainless Steel Box 20x10x3 cm	1
Michel Clips (box of 100) 12 mm	1
Operating Scissors B/S Straight 14 cm	1
Flat Handle Scalpel Concave blade 50 mm	1
Tracheal Blunt Retractor 2 Teeth	1
Kocher Forceps 1x2 Teeth Straight 14 cm	1
Halstead Forceps Straight 1x2 Teeth 13 cm	2
Michel Double Use Forceps 13 cm	1
Tissue Forceps 1x2 Teeth 14 cm	1
Dissecting Forceps No Teeth 14 cm	1
Probe With Tread 14 cm	1

BOÎTE POUR ABCÈS-SUTURES

CONTENU	Qty
Boite à instruments 20x10x3 cm	1
Agrafes de Michel (boite de 100) 12 mm	1
Ciseaux opératoires droit émoussé/pointu 14 cm	1
Manche de bistouri avec lame concave 50 mm	1
Rétracteur trachéal émoussé avec 2 Dents	1
Pince de Kocher 1x2 A/G droite 14 cm	1
Pince de Halstead droite 1x2 A/G 13 cm	2
Pince Michael double usage 13 cm	1
Pince à dissection 1x2 A/G 14 cm	1
Pince à dissection S/G 14 cm	1
Sonde 14 cm	1

■ SET 122

LAPARATOMY SURGERY SET

CONTENT	Qty
Sterilizing Stainless Steel Box 40x20x9 cm	1
Reverdin needle - average straight 20 cm	1
Mayo Scissors Straight 18 cm	1
Mayo Scissors Curved 18 cm	1
Metzemaun Scissors Curved 26 cm	1
Scalpel Handle N°4	1
Farabeuf Retractor 15 cm (pair)	1
Gosset Retractor with 3 blades Adult 22 cm	1
Mayo Pin 12 cm	2
Dartigues Uterine Elevating Forceps 25 cm	1
Kocher Forceps 1x2 Teeth Straight 14 cm	6
Allis Tissue Forceps 19 cm	2
Backhaus Towel Forceps 14 cm	3
Kelly Forceps Straight 16 cm	3
Kelly Forceps Curved 16 cm	3
Murphy-Pean Forceps Straight 14 cm	4
Terrier Forceps No Teeth 13 cm	3
Tissue Forceps 1x2 Teeth 18 cm	1
Tissue Forceps 1x2 Teeth 25 cm	1
Dissecting Forceps No Teeth 18 cm	1
Mayo-Hegar Needle Holder 20 cm	1
Bengolea Forceps Straight 1x2 Teeth 24 cm	3
Bengolea Forceps Curved No Teeth 24 cm	3
Director and Tongue tie 18 cm	1
Probe With Tread 14 cm	1
Kelly Retractor 23 cm	1

SET DE CHIRURGIE LAPAROTOMIE

CONTENU	Qty
Boite à instruments 40x20x9 cm	1
Aiguille Reverdin, moyenne, 20 cm, droite	1
Ciseaux Mayo, droits, 18 cm	1
Ciseaux Mayo, courbes, 18 cm	1
Ciseaux Metzemaun, courbes, 26 cm	1
Manche Bistouri n°4	1
Ecarteur Farabeuf, 15 cm x 16 mm, la paire	1
Ecarteur Gosset, adulte, 3 valves	1
Épingle à Instruments, 12 cm	2
Hystérolabe Dartigues, 25 cm	1
Pince Kocher, droite, A/G, 14 cm	6
Pince Allis, 19 cm	2
Pince à Champs Backhaus, 14 cm	3
Pince Kelly, S/G, droite, 16 cm	3
Pince Kelly, S/G, courbe, 16 cm	3
Pince Péan Murphy, 14 cm	4
Pince Terrier, S/G, 13 cm	3
Pince Dissection, A/G, 18 cm	1
Pince Dissection, A/G, 25 cm	1
Pince Dissection, S/G, 18 cm	1
Porte-aiguille Mayo-Hégar, 20 cm	1
Pince Bengoléa, droite, A/G, 24 cm	3
Pince Bengoléa, courbe, 8/G, 24 cm	3
Sonde Cannelée, 18 cm	1
Stylet Porte-coton, 14 cm	1
Valve Kelly, 23 cm	1

• Le contenu de chaque jeu est disponible sur demande ou peut être téléchargé de notre site www.fazzini.it sous format PDF.

• Le contenu est indicatif et certaines dimensions peuvent changer sans préavis sans affecter l'utilisation prévue.



■ SET 124

MAJOR BASIC SURGERY SET

CONTENT	Qty
Sterilizing Stainless Steel Box 40x20x9 cm	1
Michel Clips (box of 100) 14 mm	1
Mayo Scissors Straight 16 cm	1
Metzemaun Scissors Curved 18 cm	1
Operating Scissors B/B Straight 14 cm	1
Volkman Bone Curette 17 cm x diam 6 mm	1
Scalpel Handle N°4	1
Farabeuf Retractor 15 cm (pair)	1
Beckmann Retractor (4x4 teeth) 30 cm	1
Gosset Retractor with 3 blades Adult 22 cm	1
Malleable Blade Retractor 25 cm 35x25 mm	1
Kocher Forceps 1x2 Teeth Straight 14 cm	6
Mair Polypus Forceps Straight 24 cm	1
Backhaus Towel Forceps 12 cm	6
Chaput Forceps 13 cm	2
Leriche Forceps Straight 1x2 Teeth 15 cm	6
Leriche Forceps Curved No Teeth 15 cm	6
Michel Double Use Forceps 13 cm	1
Murphy-Pean Forceps Straight 14 cm	2
Tissue Forceps 1x2 Teeth 14 cm	1
Tissue Forceps 1x2 Teeth 20 cm	1
Dissecting Forceps No Teeth 14 cm	1
Dissecting Forceps No Teeth 20 cm	1
Mayo-Hegar Needle Holder 18 cm	1
Mixter-O'Shaughnessy Artery Forceps 90° 24 cm	1
Director and Tongue tie 14 cm	1
Probe With One Knob 14 cm	1
Probe With Tread 14 cm	1

BOÎTE CHIRURGIE GÉNÉRALE

CONTENU	Qty
Boîte en acier inoxydable stérilisant 40x20x9 cm	1
Agrafes de Michel (boite de 100) 14 mm	1
Ciseaux Mayo, droits, 16 cm	1
Ciseaux Metzemaun, courbes, 18 cm	1
Ciseaux Mousse, droits, 14 cm	1
Curette à Os de Volkman, 17 cm, dia. 6 mm	1
Manche Bistouri n°4	1
Ecarteur Farabeuf, 15 cm x 16 mm, la paire	1
Ecarteur Beckmann, 4x4 griffes, 30 cm	1
Ecarteur Gosset, adulte, 3 valves	1
Lame Malléable, 25 cm, 35 x 25 mm	1
Pince Kocher, droite, A/G, 14 cm	6
Pince à Pansements, Longuette, droite, 24 cm	1
Pince à Champs Backhaus, 12 cm	6
Pince de Chaput 13 cm	2
Pince Leriche, droite, A/G, 15 cm	6
Pince Leriche, courbe, S/G, 15 cm	6
Pince Michel, double usage, 13 cm	1
Pince Péan Murphy, 14 cm	2
Pince Dissection, A/G, 14 cm	1
Pince Dissection, A/G, 20 cm	1
Pince Dissection, S/G, 14 cm	1
Pince Dissection, S/G, 20 cm	1
Porte-aiguille Mayo-Hégar, 18 cm	1
Pince Mixter O'Shaughnessy, 90°, 24 cm	1
Sonde Cannelée, 14 cm	1
Stylet Olivaire, 14 cm, simple	1
Stylet Porte-coton, 14 cm	1

■ SET 200

CAESAREAN SET

CONTENT	Qty
Sterilizing Stainless Steel Box 40x20x9 cm	1
Mayo Scissors Straight 16 cm	1
Mayo Scissors Curved 17 cm	1
Scalpel Handle N°4	1
Farabeuf Retractor 12 cm (pair)	1
Farabeuf Retractor 15 cm (pair)	1
Kocher Forceps 1x2 Teeth Straight 14 cm	6
Mair Polypus Forceps Straight 24 cm	1
Backhaus Towel Forceps 12 cm	4
Kelly Forceps Straight 14 cm	6
Kelly Forceps Curved 14 cm	6
Tissue Forceps 1x2 Teeth 14 cm	1
Dissecting Forceps No Teeth 14 cm	1
Dissecting Forceps No Teeth 20 cm	1
Tissue Forceps 1x2 Teeth Fine 25 cm	1
Mayo-Hegar Needle Holder 18 cm	1
Doyen Needle Holder 14 cm	1
Doyen Vaginal Speculum 90 mm	2
Kelly Retractor 23 cm	2

BOÎTE CÉSARIENNE

CONTENU	Qty
Boite à instruments 40x20x9 cm	1
Ciseaux Mayo, droits, 16 cm	1
Ciseaux Mayo, courbes, 17 cm	1
Manche Bistouri n°4	1
Ecarteur Farabeuf, 12 cm x 12 mm, la paire	1
Ecarteur Farabeuf, 15 cm x 16 mm, la paire	1
Pince Kocher, droite, A/G, 14 cm	6
Pince à Pansements, Longuette, droite, 24 cm	1
Pince à Champs Backhaus, 12 cm	4
Pince Kelly, S/G, droite, 14 cm	6
Pince Kelly, S/G, courbe, 14 cm	6
Pince Dissection, A/G, 14 cm	1
Pince Dissection, S/G, 14 cm	1
Pince Dissection, S/G, 20 cm	1
Pince Dissection, A/G, fine, 25 cm	1
Porte-aiguille Mayo-Hégar, 18 cm	1
Porte-aiguille Doyen, 14 cm	1
Valve Doyen vaginale, 90 mm x 45 mm	2
Valve Kelly, 23 cm	2

- The content of each set is available on request or can be downloaded from our website www.fazzini.it as a PDF file.
- The content is indicative and some dimensions may change without prior notice without affecting the intended use.



■ SET 201

COMPLETE NORMAL DELIVERY SET

CONTENT	Qty
Sterilizing Stainless Steel Box 25x10x5 cm	1
Reverdin needle - average curved 20 cm	1
Mayo Scissors Straight 18 cm	1
Mayo Scissors Curved 18 cm	1
Bar Umbilical Clamp 8 cm	1
Ribemont Insufflator (without bulb)	1
Kocher Forceps 1x2 Teeth Straight 18 cm	2
Rochester-Pean Forceps Curved 16 cm	1
Backhaus Towel Forceps 14 cm	2
Chéron Forceps 24 cm	1
J.L Faure Forceps Curved 1x2 Teeth 22 cm	1
Tissue Forceps 1x2 Teeth 16 cm	1
Dissecting Forceps No Teeth 16 cm	1
Membrane Punch 19 cm	1
Director and Tongue tie 14 cm	1
Metal Female Catheter 15 cm	1

■ SET 202

DELIVERY SET

CONTENT	Qty
Mayo operating scissors curved 17cm	2
Mayo operating scissors straight 17cm	2
Bar clamp	1
Beacham amniotome 26cm	1
Backhaus towel forceps 13cm	2
Chéron dressing forceps 24 cm	1
Thumb and tissue forceps toothed 1x2 16cm	1
Thumb and tissue forceps 16cm	2
Rochester-Ochsner Haemostatic forceps straight toothed 1x2 18cm	2
Rochester-Pean haemostatic forceps curved 16cm	1
Doyen channeled director 14cm	1
Metal female catheter charr/F.G. 12	1
Instrument box 30x15x6 cm	1

■ SET 203

DILATION & CURETAGE SET

CONTENT	Qty
Sterilizing Stainless Steel Box 35x18x8 cm	1
Valleix Uterine Sound With Cursor 33 cm	1
Operating Scissors B/B Curved 18 cm	1
Gourdet Uterine Curette 25 cm x 12 mm	2
Simon Uterine Curette 25 cm x 6 mm	1
Sims Uterine Curette sharp 25 cm x 8 mm	2
Volkman Uterine Curette 25 cm x 10 mm	1
Rochester-Pean Forceps Straight 22 cm	1
Chéron Forceps 24 cm	1
J.L Faure Forceps Curved 1x2 Teeth 22 cm	1
Museux Forceps Straight 24 cm 7x5 mm	3
Pozzi Forceps Straight 24 cm	2
Foerster Forceps Straight 24 cm	2
Winter Placenta Forceps Straight 24 cm	2
Bozemann Forceps Bent 24 cm	1
Collin Vaginal Speculum 30 mm x 105 mm	1
Probe With Tread 30 cm Uterine	1

BOÎTE ACCOUCHEMENT COMPLÈTE

CONTENU	Qty
Boite à instruments 25x10x5 cm	1
Aiguille Reverdin - moyenne courbée 20 cm	1
Ciseaux de Mayo droit 18 cm	1
Ciseaux de Mayo courbe 18 cm	1
Clamp Ombilical de Bar, 8 cm	1
Insufflateur Ribemont, sans poire, 10 cm	1
Pincer de Kocher 1x2 A/G droite 18 cm	2
Pince de Rochester-Pean courbe 16 cm	1
Pince à champs de Backhaus 14 cm	2
Pince de Chéron 24 cm	1
Pince Jean-Louis Faure, courbe, A/G, 22 cm	1
Pince à dissection 1x2 A/G 16 cm	1
Pince à dissection S/G 16 cm	1
Perce-membrane, 19 cm	1
Sonde cannellée 14 cm	1
Sonde vésicale metal femme 15 cm	1

BOÎTE ACCOUCHEMENT

CONTENU	Qty
Ciseaux de Mayo courbe 17cm	2
Ciseaux de Mayo droite 17cm	2
Clamp Ombilical de Bar, 8 cm	1
Amniotome Beacham 26cm	1
Pince à champs de Backhaus 13 cm	2
Pince de Chéron 24 cm	1
Pince à dissection 1x2 A/G 16 cm	1
Pince à dissection 1x2 S/G 16 cm	2
Pince hémostatique de Rochester-Ochsner droite 1x2 A/G 18cm	2
Pince de Rochester-Pean courbe 16 cm	1
Sonde cannellée de Doyen 14 cm	1
Sonde vésicale metal femme charr/F.G. 12	1
Boite à instruments 30x15x6 cm	1

BOÎTE DE CURETAGE

CONTENU	Qty
Boite inox, 35x18x8 cm	1
Hystéromètre Valleix, avec curseur, 33 cm	1
Ciseaux Mousseux, courbes, 18 cm	1
Curette Utérine Gourdet, 25x12 mm	2
Curette Utérine Simon, 25x6 mm	1
Curette Utérine Sims, tranchante, 25x8 mm	2
Curette Utérine Volkman, 25 cm x 10 mm	1
Pince Rochester-Péan S/G, droite, 22 cm	1
Pince de Chéron 24 cm	1
Pince Jean-Louis Faure, courbe, A/G, 22 cm	1
Pince Museux, droite, 24 cm, 7x5 mm	3
Pince Pozzi, droite, 24 cm	2
Pince Foerster, striée, 24 cm, droite	2
Pince à faux germes Winter droite, 24 cm	2
Pince Bozeman, contre-coudée, 24 cm	1
Spéculum Vaginal Collin, 30 mm, long 105 mm	1
Stilet Porte-coton, 30 cm	1

- Le contenu de chaque jeu est disponible sur demande ou peut être téléchargé de notre site www.fazzini.it sous format PDF.
- Le contenu est indicatif et certaines dimensions peuvent changer sans préavis sans affecter l'utilisation prévue.



■ SET 206

EPISIOTOMY SET

CONTENT	Qty
Braun-Stadler episiotomy scissors 14,5 cm	1
Deaver operating scissors straight B/B 14cm	1
Round bowl diam. 100mm 250ml	1
Standard tissue forceps 14,5cm straight 1x2 teeth	1
Kocher haemostatic forceps delicate model straight toothed 1x2 14cm	2
Mayo-Hegar needle holder 14cm	2
Instrument box 25x12,5x6 cm	1

BOÎTE ÉPISIOTOMIE

CONTENU	Qty
Ciseaux à épisiotomie de Braun-Stadler 14,5 cm	1
Ciseaux opératoire de Deaver droites émoussé 14cm	1
Cupule en inox diam. 100mm 250ml	1
Pince à dissection A/G 14,5 cm	1
Pince hémostatique de Kocher modèle délicat droit A/G 14cm	2
Porte-aiguille de Mayo-Hegar 14cm	2
Boite à instruments 25x12,5x6 cm	1

■ SET 209

HYSTERECTOMY SURGERY SET

CONTENT	Qty
Sterilizing Stainless Steel Box 50x20x12 cm	1
Michel Clips (box of 100) 14 mm	1
Mayo Scissors Straight 20 cm	1
Metzemaum Scissors Straight 26 cm	1
Dubost Scissors Curved 26 cm	1
Yankauer Cannula 27 cm	1
Mayo Pin 18 cm	2
Dartigue Uterine Elevating Forceps 25 cm	1
Kocher Forceps 1x2 Teeth Curved 16 cm	6
Backhaus Towel Forceps 14 cm	4
Doyen Intestinal Clamp 23 cm Straight	2
Michel Removing Forceps 14 cm	1
Michel Applying Forceps 15 cm	1
Museux Forceps Straight 24 cm 7 x 5 mm	4
Tissue Forceps 1x2 Teeth 20 cm	1
Heart Shaped Forceps 16 cm	2
Babcock Forceps 20 cm	4
Guyon Forceps 23 cm	2
Probe With Tread 30 cm Uterin	1
Doyen Vaginal Speculum 60 mm	1
Doyen Vaginal Speculum 90 mm	1
Doyen Vaginal Speculum 120 mm	1
Kelly Retractor 23 cm	2

BOÎTE POUR HYSTÉRECTOMIE

CONTENU	Qty
Boite à instruments 50x20x12 cm	1
Agrafes de Michel (boite de 100) 14 mm	1
Ciseaux de Mayo droit 20 cm	1
Ciseaux de Metzemaum droit 26 cm	1
Ciseaux de Dubost courbe 26 cm	1
Cannula de Yankauer 27 cm	1
Épingle à instruments de Mayo 18 cm	2
Pinces hystérolabes de Dartigues 25 cm	1
Pinces de Kocher A/G courbe 16 cm	6
Pince à champs de Backhaus 14 cm	4
Pince intestinale de Doyen 23 cm Droite	2
Pince pour ôter les agrafes de Michael 14 cm	1
Pince pour mettre les agrafes de Michael 15 cm	1
Pince de Museux droite 24 cm 7 x 5 mm	4
Pince à dissection A/G 20 cm	1
Pince en coeur 16 cm	2
Pince de Babcock 20 cm	4
Pince de Guyon 23 cm	2
Stylet porte-coton 30 cm	1
Spéculum vaginal de Doyen 60 mm	1
Spéculum vaginal de Doyen 90 mm	1
Spéculum vaginal de Doyen 120 mm	1
Retracteur de Kelly 23 cm	2

■ SET 210

IUD IMPLANTATION AND REMOVING SURGICAL SET

CONTENT	Qty
Serving Forceps Jar 50x180 mm	1
Stainless Steel Bowl 80 mm / 165 ml with spout	2
Sterilizing Stainless Steel Box 35x18x8 cm	1
Valleix Uterine Sound With Cursor 33 cm	1
Sims Scissors B/B curved 20 cm	1
Hook to remove IUD	1
Rochester-Pean Forceps Curved no teeth 22 cm	1
Mair Polypus Forceps Straight 24 cm	1
Pozzi Forceps Straight 24 cm	1
Foerster Forceps Straight 24 cm	1
Ciceron Forceps For Grasping the Coil 28 cm	1
Therrum Forceps for applying and removing the coil 27 cm	1
Novack Uterine Sound	1
Cusco Vaginal Speculum pliable 32 mm x 90 mm	2
Probe With Tread 30 cm Uterin	1

BOÎTE INSERTION ET ENLÈVEMENT DIU

CONTENU	Qty
Porte-pince à servir, dia. 50 mm, haut. 180 mm	1
Cupule à Bee, inox, dia. 80 mm, 165 ml	2
Boite inox, 35x18x8 cm	1
Hystéromètre Valleix, avec curseur, 33 cm	1
Ciseaux Sims, mousses, 20 cm, courbes	1
Crochet à Ôter le Stérilet, 25 cm	1
Pince Rochester-Péan, S/G, courbe, 22 cm	1
Pince à Pansements, Longuette, droite, 24 cm	1
Pince Pozzi, droite, 24 cm	1
Pince Foerster, striée, 24 cm, droite	1
Pince Circéron, pour préhension du stérilet, 28 cm	1
Pince Therrum, 27 cm	1
Canule à Biospie de Novack, 23 cm (sonde curette)	1
Spéculum Vaginal de Cusco, pliant, 32 mm, long 90 mm	2
Stylet Porte-coton, 30 cm	1

- The content of each set is available on request or can be downloaded from our website www.fazzini.it as a PDF file.
- The content is indicative and some dimensions may change without prior notice without affecting the intended use.



■ SET 300

BONE SURGERY SET

CONTENT	Qty
Sterilizing Stainless Steel Box 50x20x12 cm	1
Faraboeuf Chisel 21cm x 10mm	1
Faraboeuf Chisel 21cm x 15mm	1
Faraboeuf Chisel 21cm x 20mm	1
Volkman Bone Curette monobloc 28 cm x diam 10 mm	1
Volkman Bone Curette monobloc 28 cm x diam 12 mm	1
Volkman Bone Curette monobloc 28 cm x 14 mm	1
Cushing Hook 14 cm	4
Scalpel Handle N°3	1
Scalpel Handle N°4	1
Scalpel Handle N°3 Long	1
Farabeuf Bone Holding Forceps 26 cm	1
Verbrugge Bone Holding Forceps Red. - lower Sharped Jaw Bent 24cm	1
Verbrugge Bone Holding Forceps Grasping Jaws to Prehensile Bent 24 cm 2	1
Farabeuf Retractor 12 cm (pair)	1
Farabeuf Retractor 15 cm (pair)	1
Beckmann Retractor (4x4 teeth) 30 cm	1
Smith Peterson Gouge Double Bent 24 cm x 25 mm	1
Cauchoix Gouge Convex 25 cm x 18 mm	1
Cauchoix Gouge Concav 25 cm x 18 mm	1
Lambotte Bone hook 26 cm	1
Stainless Steel Collin Mallet Double Heads 20 cm 500 gr	1
Lambotte Osteotome Straight 20 cm x 10 mm	1
Lambotte Osteotome Straight 20 cm x 20 mm	1
Lambotte Osteotome Straight 20 cm x 25 mm	1
Cauchoix Osteotome 21 cm x 16 mm	1
Cauchoix Osteotome 21 cm x 20 mm	1
Kocher Forceps 1x2 Teeth Straight 14 cm	10
Rochester-Pean Forceps Curved 18 cm	4
Backhaus Towel Forceps 14 cm	10
Tissue Forceps 1x2 Teeth 16 cm	1
Dissecting Forceps No Teeth 16 cm	1
Liston Bone Cutting Multiaction Curved 22 cm	1
Luer Bone Rongeur Multiaction Curved 22 cm	1
Gouge Forceps Single Articulation 20 cm 8 mm	1
Square Point 18 cm x 3 mm	1
Square Point 18 cm x 5 mm	1
Square Point 18 cm x 8 mm	1
Farabeuf Bone Raspatory Straight 15 cm x 12 mm	1
Faraboeuf Bone Raspatory Curved 15 cm x 12 mm	1
Lambotte Bone Raspatory 21 cm x 10 mm	1
Lambotte Bone Raspatory 21 cm x 15 mm	1
Lambotte Bone Raspatory 21 cm x 25 mm	1
Aubigné Bone Raspatory Straight 15mm	1

BOÎTE CHIRURGIE OSSEUSE

CONTENU	Qty
Boîte de stérilisation en acier inoxydable 50x20x12 cm	1
Burin Faraboeuf 21cm x 10mm	1
Burin Faraboeuf 21cm x 15mm	1
Burin Faraboeuf 21cm x 20mm	1
Curette en os monobloc 28 cm x dia 10 mm	1
Curette en os monobloc 28 cm x dia 12 mm	1
Curette en os monobloc 28 cm x dia 14 mm	1
Crochet Cushing, boutonné 14 cm	4
Manche bistouri N° 3	1
Manche bistouri N° 4	1
Manche bistouri N° 3 Longue	1
Davier Farabeuf 26 cm	1
Davier Verbrugge, réducteur, mors acérés, coudé 24cm	1
Davier Verbrugge, préhenseur, mors dentés, coudé 24cm	2
Ecarteur Farabeuf 12cmx12mm la paire	1
Ecarteur Farabeuf 15cmx16mm la paire	1
Ecarteur Beckmann, 4x4 griffes, 30 cm	1
Gouge de Smith Peterson contre-coudeé 24cmx25mm	1
Gouge de Cauchoix, convexe 25cmx18mm	1
Gouge de Cauchoix, concav 25cmx18mm	1
Crochet à Os Lambotte 26 cm	1
Maillet Collin, dia 34mm, 20cm, 500 gr, 2 tête, inox	1
Ostéotome Lambotte 20 cm droit 10 mm	1
Ostéotome Lambotte 20 cm droit 20 mm	1
Ostéotome Lambotte 20 cm droit 25 mm	1
Ostéotome de Cauchoix 21 cm x 16 mm	1
Ostéotome de Cauchoix 21 cm x 20 mm	1
Pince Kocher, droites, A/G 14 cm	10
Pince Rochester-Pean, S/G, courbé, 18 cm	4
Pince à champs Backhaus 14 cm	10
Pince a dissection A/G 16 cm	1
Pince a dissection S/G 16 cm	1
Pince coupante Liston, 4 articulations, courbe, 22cm	1
Pince Goude Luer, 4 articulations, mors 8mm, courbe, 22 cm	1
Pince Gouge, simple articulation, droite, 20 cm, mors 8 mm	1
Pointe carrée 18cm x 3mm	1
Pointe carrée 18cm x 5mm	1
Pointe carrée 18cm x 8mm	1
Rugine Farabeuf, droite, 15cm x 12mm	1
Rugine Farabeuf, courbe, 15cm x 12mm	1
Rugine Lambotte 21cm x 10mm	1
Rugine Lambotte 21cm x 15mm	1
Rugine Lambotte 21cm x 25mm	1
Rugine Merle Aubigné/Ginestet, droite, 23cmx15mm	1

- Le contenu de chaque jeu est disponible sur demande ou peut être téléchargé de notre site www.fazzini.it sous format PDF.
- Le contenu est indicatif et certaines dimensions peuvent changer sans préavis sans affecter l'utilisation prévue.



SUPER CUT SCISSORS

CISEAUX



IRIS SUPER CUT 10 cm
113 91 0685
Straight sharp / Droite pointue
113 91 0686
Curved sharp / Courbe pointue



JABALEY
SUPER CUT 12 cm
113 91 0687
Straight sharp / Droite pointue
113 91 0688
Curved sharp / Courbe pointue



STEVENS
SUPER CUT 12,5 cm
113 91 0689
Straight sharp / Droite
pointue
113 91 0690
Curved sharp / Courbe
pointue



LISTER 14 cm
SUPER CUT
113 91 0691
Curved / Courbe



MAYO
SUPER CUT 15 cm
113 91 0692
Straight / Droite
113 91 0693
Curved / Courbe



MAYO-STILLE
113 91 0694
Straight / Droite 15cm
113 91 0695
Straight / Droite 17cm
113 91 0696
Curved / Courbe 15cm
113 91 0697
Curved / Courbe 17cm



MAYO-HARRINGTON
SUPER CUT
113 91 0698
Straight / Droite 20cm
113 91 0699
Straight / Droite 23cm



RANGEL-STILLE
113 91 0700
Curved / Courbe 12,5cm
113 91 0701
Curved / Courbe 15cm
113 91 0702
Curved / Courbe 18cm
113 91 0703
Curved / Courbe 20cm
113 91 0704
Curved / Courbe 23cm



METZEMBAUM
SUPER CUT
113 91 0705
Straight / Droite 15cm
113 91 0706
Straight / Droite 18cm
113 91 0707
Straight / Droite 20cm
113 91 0708
Straight / Droite 23cm
113 91 0709
Straight / Droite 26cm



METZEMBAUM
SUPER CUT
113 91 0710
Curved / Courbe 15cm
113 91 0711
Curved / Courbe 18cm
113 91 0712
Curved / Courbe 20cm
113 91 0713
Curved / Courbe 23cm
113 91 0714
Curved / Courbe 26cm



BABY METZEMBAUM
SUPER CUT 12,5 cm
113 91 0715
Straight / Droite
113 91 0716
Curved / Courbe



IRIS SUPER CUT 11,5 cm
w/out TC - sans TC
113 91 0717
Straight / Droite
113 91 0718
Curved / Courbe



IRIS SUPER CUT 11,5 cm
with TC - avec TC
113 91 0719
Straight / Droite
113 91 0720
Curved / Courbe



LA GRANDE SUPER CUT
11,5 cm
113 91 0721
Curved / Courbe
w/out TC - sans TC
113 91 0722
Curved / Courbe
with TC - avec TC



SCISSORS WITH TUNGSTEN-CARBIDE INSERT

CISEAUX DE CARBURE TUNGSTENE



STRABISMUS
11.0974 11,5 cm
Straight / Droite
11.0975 11,5 cm
Curved / Courbe



POTTS-SMITH
11.0987 19 cm 25°
Curved sharp / Courbe
pointue
11.0988 19 cm 45°
Curved sharp / Courbe
pointue
11.0989 19 cm 60°
Curved sharp / Courbe
pointue



MAYO-LEXER
11.0979 16 cm
Straight / Droite
11.0980 16 cm
Curved / Courbe



MAYO-HARRINGTON
11.0981 23 cm
Straight / Droite
11.0982 28 cm
Straight / Droite
11.0983 23 cm
Curved / Courbe
11.0984 28 cm
Curved / Courbe



TOENNIS-ADSON
11.0985 18 cm
Straight / Droite



IRIS
11.0910 11,5 cm
Straight sharp / Droite
pointue
11.0911 11,5 cm
Curved sharp / Courbe
pointue
11.0912 11,5 cm 25°
Curved sharp / Courbe
pointue



GOLDMAN-FOX
11.0913 13 cm
Straight / Droite
11.0914 14 cm
Curved / Courbe



BABY-LEXER
11.0990 10 cm
Straight / Droite
11.0991 10 cm
Curved / Courbe



RAGNELL
11.0992 11,5 cm
Curved / Courbe



STANDARD
11.0993 14,5 cm
Straight S-B / Droite P-M
11.0994 14,5 cm
Curved S-B / Courbe P-M
11.0995 14,5 cm
Straight S-S / Droite P-P
11.0996 14,5 cm
Curved S-S / Courbe P-P
11.0997 14,5 cm
Straight B-B / Droite M-M
11.0998 14,5 cm
Curved B-B / Courbe M-M



MAYO
 11.0999 TC 14,5 cm
 Straight / Droite
 11.1000 TC 17 cm
 Straight / Droite
 11.1001 TC 23 cm
 Straight / Droite
 11.1002 TC 14,5 cm
 Curved / Courbe
 11.1003 TC 17 cm
 Curved / Courbe
 11.1004 TC 23 cm
 Curved / Courbe



SIMS
 11.1006 TC 23 cm
 Straight / Droite
 11.1007 TC 23 cm
 Curved / Courbe



UNIVERSAL
 11.1008 TC 12,5 cm



DEBAKEY 25°
 11.1009 TC 19 cm
 11.1010 TC 23 cm
 11.1011 TC 28 cm
 DEBAKEY 45°
 11.1012 TC 19 cm
 11.1013 TC 23 cm
 11.1014 TC 28 cm
 DEBAKEY 60°
 11.1015 TC 19 cm
 11.1016 TC 23 cm
 11.1017 TC 28 cm



METZENBAUM STRAIGHT/DROITE
 11.1018 TC 14,5 cm
 11.1019 TC 18 cm
 11.1020 TC 20 cm
 11.1021 TC 23 cm
 11.1022 TC 25 cm
 11.1023 TC 28 cm
 11.1024 TC 30 cm
 METZENBAUM CURVED/COURBE
 11.1025 TC 14,5 cm
 11.1026 TC 18 cm
 11.1027 TC 20 cm
 11.1028 TC 23 cm
 11.1029 TC 25 cm
 11.1030 TC 28 cm
 11.1031 TC 30 cm



METZENBAUM-FINO STRAIGHT/DROITE
 11.1032 TC 14,5 cm
 11.1033 TC 18 cm
 11.1034 TC 20 cm
 11.1035 TC 23 cm
 11.1036 TC 25 cm
 11.1037 TC 28 cm
 METZENBAUM-FINO CURVED/COURBE
 11.1038 TC 14,5 cm
 11.1039 TC 18 cm
 11.1040 TC 20 cm
 11.1041 TC 23 cm
 11.1042 TC 25 cm
 11.1043 TC 28 cm



METZENBAUM-X FINO STRAIGHT/DROITE
 11.1044 TC 14,5 cm
 11.1045 TC 18 cm
 11.1046 TC 20 cm
 11.1047 TC 23 cm
 CURVED/COURBE
 11.1048 TC 14,5 cm
 11.1049 TC 18 cm
 11.1050 TC 20 cm
 11.1051 TC 23 cm



METZENBAUM-FINO CURVED/COURBE
 Blunt/Mousse
 11.1052 TC 18 cm
 11.1055 TC 20 cm
 11.1053 TC 23 cm
 CURVED/COURBE Sharp/Pointue
 11.1056 TC 18 cm
 11.1054 TC 20 cm
 11.1057 TC 23 cm



KELLY
 11.1058 TC 16 cm
 Straight / Droite
 11.1059 TC 16 cm
 Curved / Courbe
 LOCKLIN
 11.1060 TC 16 cm
 Curved / Courbe



DEAN
 11.1061 TC 17 cm
 Smooth / Lisse
 11.1062 TC 17 cm
 Serrated / Dentée

NEEDLE HOLDER WITH TUNGSTEN-CARBIDE INSERT

PORTE-AIGUILLE DE CARBURE TUNGSTENE



BABY-RILE
 11.3609 15 cm
 CRILE WOOD
 11.3610 15 cm
 11.3611 18 cm
 11.3612 20 cm
 11.3613 23 cm



MAYO-HEGAR
 11.3614 16 cm
 11.3615 18 cm
 11.3616 20 cm
 11.3617 24 cm
 11.3618 26 cm
 11.3619 30 cm



DEBAKEY
 11.3620 18 cm
 11.3621 20 cm
 11.3622 23 cm
 11.3623 25 cm
 11.3624 31 cm
 11.3625 37 cm



MICRO-VASCULAR
 11.3627 15 cm
 11.3628 18 cm
 11.3629 20 cm
 11.3630 23 cm



HEANEY
 11.3639 20 cm
 11.3640 24 cm
 11.3641 28 cm



STRATTE
 11.3642 21 cm
 11.3643 23 cm



GILLIES-MINI
 11.3654 14 cm



GILLIES
 11.3655 16 cm



RYDER
 11.3656 13 cm
 11.3657 15 cm
 11.3658 18 cm
 11.3659 20 cm
 11.3660 23 cm
 11.3661 26 cm



FINOCCHIETTO
 11.3632 21 cm
 11.3633 27 cm



DIETRICH
 11.3668 18 cm
 11.3669 20 cm
 11.3670 23 cm
 11.3671 26 cm



CASTROVIEJO
 Straight / Droite
 Smooth / Lisse Serrated/Dentee
 11.3674 14 cm 11.3677 14 cm
 11.3675 18 cm 11.3678 18 cm
 11.3676 21 cm 11.3679 21 cm
 Curved / Courbe
 Smooth / Lisse Serrated/Dentee
 11.3680 14 cm 11.3683 14 cm
 11.3681 18 cm 11.3684 18 cm
 11.3682 21 cm 11.3685 21 cm



ARRUGA
 11.3687 16 cm
 Straight / Droite
 11.3688 16 cm
 Curved / Courbe



MATHIEU
 11.3647 14 cm
 11.3648 17 cm
 11.3649 20 cm
 11.3650 23 cm



OPERATING SCISSORS | CISEAUX A CHIRURGIE

OPERATING SCISSORS / CISEAUX A CHIRURGIE
STRAIGHT / DROITE



Code	Dim.	Code	Dim.	Code	Dim.
11.1000	10,5 cm	11.1020	10,5 cm	11.1040	10,5 cm
11.1001	11,5 cm	11.1021	11,5 cm	11.1041	11,5 cm
11.1002	13 cm	11.1022	13 cm	11.1042	13 cm
11.1003	14,5 cm	11.1023	14,5 cm	11.1043	14,5 cm
11.1004	15,5 cm	11.1024	15,5 cm	11.1044	15,5 cm
11.1005	16,5 cm	11.1025	16,5 cm	11.1045	16,5 cm
11.1006	18,5 cm	11.1026	18,5 cm	11.1046	18,5 cm
11.1007	20 cm	11.1027	20 cm	11.1047	20 cm

OPERATING SCISSORS / CISEAUX A CHIRURGIE
CURVED / COURBE



Code	Dim.	Code	Dim.	Code	Dim.
11.1010	11,5 cm	11.1030	11,5 cm	11.1050	11,5 cm
11.1011	13 cm	11.1031	13 cm	11.1051	13 cm
11.1012	14,5 cm	11.1032	14,5 cm	11.1052	14,5 cm
11.1013	15,5 cm	11.1033	15,5 cm	11.1053	15,5 cm
11.1014	16,5 cm	11.1034	16,5 cm	11.1054	16,5 cm
11.1015	18,5 cm	11.1035	18,5 cm	11.1055	18,5 cm
11.1016	20 cm	11.1036	20 cm	11.1056	20 cm

OPERATING SCISSORS / CISEAUX A CHIRURGIE
DEAVER



Code	Dim.	
11.1060	14 cm	Straight B-B / Droite M-M
11.1061	14 cm	Curved B-B / Courbe M-M
11.1070	14 cm	Straight S-B / Droite M-P
11.1071	14 cm	Curved S-B / Courbe M-P
11.1080	14 cm	Straight S-S / Droite P-P
11.1081	14 cm	Curved S-S / Courbe P-P

OPERATING SCISSORS /
CISEAUX A CHIRURGIE

MAYO	
Straight / Droite	Curved / Courbe
11.1090 14,5 cm	11.1093 14,5 cm
11.1091 17 cm	11.1094 17 cm
11.1092 23 cm	11.1095 23 cm
MAYO-STILLE	
Straight / Droite	Curved / Courbe
11.1100 15 cm	11.1102 15 cm
11.1101 17 cm	11.1103 17 cm



OPERATING SCISSORS /
CISEAUX A CHIRURGIE

IRIS STANDARD	
Straight / Droite	Curved / Courbe
11.1110 9 cm	11.1112 9 cm
11.1111 11 cm	11.1113 11 cm



OPERATING SCISSORS /
CISEAUX A CHIRURGIE

MAYO-HARRINGTON	
Straight / Droite	Curved / Courbe
11.0922 23 cm	11.0923 23 cm
	11.0924 30 cm



OPERATING SCISSORS /
CISEAUX A CHIRURGIE

THOREK	
Straight / Droite	Curved / Courbe
11.0925 19 cm	11.0926 23 cm





OPERATING SCISSORS /
CISEAUX A CHIRURGIE
KLINGENBERGLOTH
11.0927 23 cm
Curved / Courbe



OPERATING SCISSORS /
CISEAUX A CHIRURGIE
SATINSKY
11.0928 24,5 cm
Curved / Courbe



OPERATING SCISSORS /
CISEAUX A CHIRURGIE
11.1195 11 cm
Straight / Droite
11.1196 11 cm
Curved / Courbe



OPERATING SCISSORS /
CISEAUX A CHIRURGIE
11.1197 15 cm
Straight / Droite
11.1198 15 cm
Curved / Courbe



OPERATING SCISSORS /
CISEAUX A CHIRURGIE
MCINDOE
11.1199 19 cm
Straight / Droite





OPERATING SCISSORS /
CISEAUX A CHIRURGIE
CRAFOORD
11.1200 30 cm
Curved / Courbe

DISSECTING FORCEPS

PINCES À DISSECTION





DISSECTING SCISSORS /
CISEAUX A DISSECTION
LEXER
 
Straight / Droite 11.1120 16 cm
Curved / Courbe 11.1122 16 cm
11.1121 21 cm 11.1123 21 cm





DISSECTING SCISSORS /
CISEAUX A DISSECTION
LEXER-BABY
 
Straight / Droite 11.1124 10 cm
Curved / Courbe 11.1125 10 cm



DISSECTING SCISSORS /
CISEAUX A DISSECTION
METZENBAUM
 
Straight / Droite 11.1130 15 cm
Curved / Courbe 11.1140 15 cm
11.1131 18 cm 11.1141 18 cm
11.1132 20 cm 11.1142 20 cm
11.1133 23 cm 11.1143 23 cm
11.1134 25 cm 11.1144 25 cm
11.1135 28 cm 11.1145 28 cm
11.1136 30 cm 11.1146 30 cm



DISSECTING SCISSORS /
CISEAUX A DISSECTION
METZENBAUM FINO
 
Straight / Droite 11.1150 15 cm
Curved / Courbe 11.1160 15 cm
11.1151 18 cm 11.1161 18 cm
11.1152 20 cm 11.1162 20 cm
11.1153 23 cm 11.1163 23 cm



UMBILICAL SCISSORS

CISEAUX OMBELICAUX



UMBILICAL SCISSORS /
CISEAUX OMBELICAUX
U.S.A MODEL
11.1190 10,5 cm



UMBILICAL SCISSORS /
CISEAUX OMBELICAUX
BUSCH
11.1191 16 cm



UMBILICAL SCISSORS /
CISEAUX OMBELICAUX
SCHUMACHER
11.1192 14 cm



EPISIOTOMY SCISSORS /
CISEAUX A EPISIOTOMIE
BRAUN-STADLER
11.1193 14,5 cm
11.1194 22 cm

GYNAECOLOGICAL SCISSORS

CISEAUX GYNECOLOGIQUES



GYNAECOLOGICAL SCISSORS /
CISEAUX GYNECOLOGIQUES
SIMS
Straight / Droite 20 cm Curved / Courbe 20 cm
11.1170 20 cm 11.1172 20 cm
11.1171 23 cm 11.1173 23 cm



GYNAECOLOGICAL SCISSORS /
CISEAUX GYNECOLOGIQUES
SIEBOLD
11.1180 24 cm
Curved / Courbe



GYNAECOLOGICAL SCISSORS /
CISEAUX GYNECOLOGIQUES
WERTHEIM
11.1181 22,5 cm
Curved / Courbe



GYNAECOLOGICAL SCISSORS /
CISEAUX GYNECOLOGIQUES
DOYEN
Straight / Droite 17,5 cm Curved / Courbe 17,5 cm
11.1182 17,5 cm 11.1183 17,5 cm



GYNAECOLOGICAL SCISSORS /
CISEAUX GYNECOLOGIQUES
DUBOIS
Straight / Droite 27 cm Curved / Courbe 27 cm
11.1184 27 cm 11.1185 27 cm



GYNAECOLOGICAL SCISSORS /
CISEAUX GYNECOLOGIQUES
KELLY
Straight / Droite 16 cm Curved / Courbe 16 cm
11.1186 16 cm 11.1188 16 cm
11.1187 18 cm 11.1189 18 cm



ENTEROTOMY SCISSORS | CISEAUX À ENTÈROTOMIE



ENTEROTOMY SCISSORS / CISEAUX À ENTÈROTOMIE

Code 11.1210	Dim. 21 cm	Code 11.1211
		Dim. 21 cm
		Code 11.1212
		Dim. 21 cm

LIGATURE SCISSORS | CISEAUX À LIGATURES



LIGATURE SCISSORS / CISEAUX À LIGATURES

SPENCER Sharp / Pointue	NORTHBENT Blunt / Mousse	LITTAUER
11.1213 9 cm	11.1215 13 cm	11.1216 14 cm
11.1214 11 cm		

BANDAGE SCISSORS | CISEAUX A BANDAGES



BANDAGE SCISSORS / CISEAUX A BANDAGES IISTER

11.1250	11 cm
11.1251	14 cm
11.1252	18 cm
11.1253	20 cm



BANDAGE SCISSORS / CISEAUX A BANDAGES BERGMANN

11.1254 23 cm



BANDAGE SCISSORS / CISEAUX A BANDAGES ESMARCH

11.1255	20 cm
11.1256	22 cm



BANDAGE SCISSORS / CISEAUX A BANDAGES UNIVERSAL

11.1257	15 cm
11.1258	18 cm

PLASTER OF PARIS INSTRUMENTS | INSTRUMENTS POUR PLÂTRE



PLASTER OF PARIS INSTRUMENTS / INSTRUMENTS POUR PLÂTRE ENGEL

11.1259	BERGMANN
11.1260	



PLASTER OF PARIS INSTRUMENTS / INSTRUMENTS POUR PLÂTRE STILLE

11.1261	23 cm
11.1262	26 cm
11.1263	37 cm



PLASTER OF PARIS INSTRUMENTS/
INSTRUMENTS POUR PLÂTRE
WOLFF

11.1264 18 cm
11.1265 24 cm



PLASTER OF PARIS INSTRUMENTS/
INSTRUMENTS POUR PLÂTRE
BEESON

11.1266 36 cm
11.1267 27 cm



PLASTER OF PARIS INSTRUMENTS/
INSTRUMENTS POUR PLÂTRE
WALTON

11.1268 23 cm



PLASTER OF PARIS INSTRUMENTS/
INSTRUMENTS POUR PLÂTRE
STILLE-HAGLUND

11.1269 28 cm

SCISSORS, OPHTHALMOLOGY, NASAL

CISEAUX POUR OPHTHALMOLOGIE, NASALE



SCISSORS, OPHTHALMOLOGY,
NASAL/
CISEAUX POUR OPHTHALMOLOGIE,
NASALE
AEBLI

Straight / Droite Curved / Courbe
11.1220 9 cm 11.1221 9 cm



SCISSORS, OPHTHALMOLOGY,
NASAL/
CISEAUX POUR OPHTHALMOLOGIE,
NASALE
STEVENS

Straight / Droite
11.1222 11 cm Sharp/Pointue
11.1224 11 cm Blunt/Mousse
Curved / Courbe
11.1223 11 cm Sharp/Pointue
11.1225 11 cm Blunt/Mousse



SCISSORS, OPHTHALMOLOGY,
NASAL/
CISEAUX POUR OPHTHALMOLOGIE,
NASALE

KILNER
Straight / Droite Curved / Courbe
11.0964 12 cm 11.0965 12 cm
11.0966 15 cm

COTTLE
Curved / Courbe
11.1226 16 cm



SCISSORS, OPHTHALMOLOGY,
NASAL/
CISEAUX POUR OPHTHALMOLOGIE,
NASALE

JOSEPH
Straight / Droite
11.0968 14 cm Smooth / Lisse
11.0969 14 cm Serrated / Dentée
Curved / Courbe
11.0970 14 cm Smooth / Lisse
11.0971 14 cm Serrated / Dentée

SCISSORS, OPHTHALMOLOGY

CISEAUX POUR OPHTHALMOLOGIE



SCISSORS, OPHTHALMOLOGY/
CISEAUX POUR OPHTHALMOLOGIE

WESTCOTT
11.1270 11 cm S-S/PP
11.1271 11 cm B-B/MM



SCISSORS, OPHTHALMOLOGY/
CISEAUX POUR OPHTHALMOLOGIE

NOYES
11.1272 12 cm



SCISSORS, OPHTHALMOLOGY/
CISEAUX POUR OPHTALMOLOGIE

WECKER
11.1273 11 cm S/S-P/P
11.1274 11 cm S/B-P/M
11.1275 11 cm B/B-M/M



SCISSORS, OPHTHALMOLOGY/
CISEAUX POUR OPHTALMOLOGIE

CASTROVIEJO Sharp/Pointue
11.1276 10 cm



SCISSORS, OPHTHALMOLOGY/
CISEAUX POUR OPHTALMOLOGIE

CASTROVIEJO Blunt/Mousse
11.1277 10 cm



SCISSORS, OPHTHALMOLOGY/
CISEAUX POUR OPHTALMOLOGIE

VANNAS
Straight / Droite
11.1278 8 cm
Curved / Courbe
11.1279 8 cm

TONSIL, VASCULAR SCISSORS | CISEAUX AMYGDALÉ, VASCULAIRES



TONSIL, VASCULAR SCISSORS/
CISEAUX AMYGDALÉ, VASCULAIRES

DEAN
Straight / Droite
11.1230 17 cm
Curved / Courbe
11.1231 17 cm



TONSIL, VASCULAR SCISSORS/
CISEAUX AMYGDALÉ, VASCULAIRES

PRINCE
Curved / Courbe
11.1232 17 cm



TONSIL, VASCULAR SCISSORS/
CISEAUX AMYGDALÉ, VASCULAIRES

11.1233 11 cm



TONSIL, VASCULAR SCISSORS/
CISEAUX AMYGDALÉ, VASCULAIRES

POTTS-DE MARTEL
11.1234 21 cm 25°
11.1235 24 cm 45°



TONSIL, VASCULAR SCISSORS/
CISEAUX AMYGDALÉ, VASCULAIRES

DE BAKÉY
11.0950 16 cm 25°
11.0951 16 cm 45°



TONSIL, VASCULAR SCISSORS/
CISEAUX AMYGDALÉ, VASCULAIRES

DEBAKEY
11.1236 16 cm 25°
11.1237 23 cm 25°
11.1238 28 cm 25°
11.1239 16 cm 45°
11.1240 23 cm 45°
11.1241 28 cm 45°
11.1242 16 cm 60°
11.1243 23 cm 60°
11.1244 28 cm 60°



DISSECTING FORCEPS | PINCES À DISSECTION



DISSECTING FORCEPS / PINCES À DISSECTION

NORMAL		NARROW	
11.2000	11,5 cm	11.2010	11,5 cm
11.2001	13 cm	11.2011	13 cm
11.2002	14,5 cm	11.2012	14,5 cm
11.2003	16 cm	11.2013	18 cm
11.2004	18 cm		
11.2005	20 cm		
11.2006	25 cm		
11.2007	30 cm		



DISSECTING FORCEPS / PINCES À DISSECTION

ADSON	
11.2020	12 cm
11.2021	15 cm



DISSECTING FORCEPS / PINCES À DISSECTION

POTTS-SMITH	
11.2030	20 cm
11.2031	25 cm
11.2032	30 cm
11.2040	20 cm 1:2
11.2041	25 cm 1:2
11.2042	30 cm 1:2



DISSECTING FORCEPS / PINCES À DISSECTION

CUSHING	
11.2050	17 cm



DISSECTING FORCEPS / PINCES À DISSECTION

NORMAL 1:2		NARROW 1:2	
11.2060	11,5 cm	11.2070	13 cm
11.2061	13 cm	11.2071	14,5 cm
11.2062	14,5 cm	11.2072	16 cm
11.2063	16 cm		
11.2064	18 cm		
11.2065	20 cm		
11.2066	25 cm		
11.2067	30 cm		



DISSECTING FORCEPS / PINCES À DISSECTION

CUSHING 1:2	
11.2130	17 cm



DISSECTING FORCEPS / PINCES À DISSECTION

ADSON 1:2		ADSON-BROWN 7:7	
11.2110	12 cm	11.2120	12 cm
11.2111	15 cm		



DISSECTING FORCEPS / PINCES À DISSECTION

DUVAL	
11.2145	14,5 cm



DISSECTING FORCEPS / PINCES À DISSECTION

RUSSIAN MODEL	
11.2146	15 cm
11.2147	20 cm
11.2148	25 cm



DISSECTING FORCEPS / PINCES À DISSECTION

McINDOE	
11.2149	15 cm



DISSECTING FORCEPS /
PINCES À DISSECTION

GRAEFE

Straight / Droite
11.0010 10 cm
Half curved / Mi-courbe
11.0011 10 cm
Curved / Courbe
11.0012 10 cm

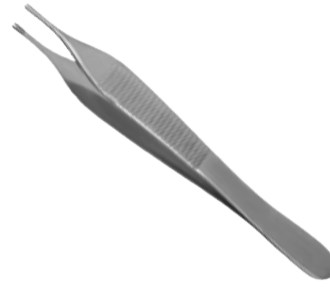

DISSECTING FORCEPS /
PINCES À DISSECTION

EWALD
11.0013 10 cm
ADSON
11.0014 10 cm



DISSECTING FORCEPS /
PINCES À DISSECTION

CUSHING

Straight / Droite
11.0015 18 cm
Curved / Courbe
11.0016 18 cm



DISSECTING FORCEPS /
PINCES À DISSECTION

GERALD

Straight / Droite
11.0017 18 cm
Curved / Courbe
11.0018 18 cm



DISSECTING FORCEPS /
PINCES À DISSECTION

GERALD

11.0019 18 cm



DISSECTING FORCEPS /
PINCES À DISSECTION

DEBAKEY-GERALD
11.0020 18 cm

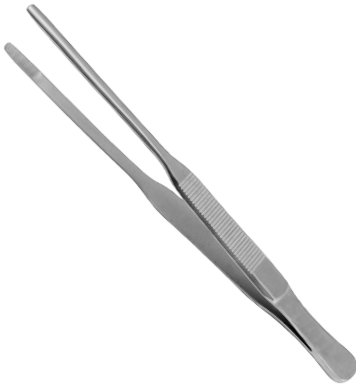

DISSECTING FORCEPS /
PINCES À DISSECTION

DUEHRSEN

11.0021 20 cm



DISSECTING FORCEPS /
PINCES À DISSECTION

TAYLOR

Straight serrated / Droite dentée
11.0022 18 cm
Curved serrated / Courbe dentée
11.0023 18 cm
Straight smooth / Droite lisse
11.0024 18 cm
Curved smooth / Courbe lisse
11.0025 18 cm



11.0027

11.0026

DISSECTING FORCEPS /
PINCES À DISSECTION

TAYLOR-CUSHING

11.0026 18 cm
11.0027 18 cm



DISSECTING FORCEPS /
PINCES À DISSECTION

GRAEFE

Straight / Droite
11.0028 10 cm 1:2
Half curved / Mi-courbe
11.0029 10 cm 1:2
Curved / Courbe
11.0030 10 cm 1:2



DISSECTING FORCEPS /
PINCES À DISSECTION

BROPHY
11.0042 20 cm 1:2



DISSECTING FORCEPS /
PINCES À DISSECTION

TAYLOR
Straight / Droite
11.0048 18 cm 1:2
Curved / Courbe
11.0049 18 cm 1:2



DISSECTING FORCEPS /
PINCES À DISSECTION

TAYLOR-CUSHING
11.0051 18 cm

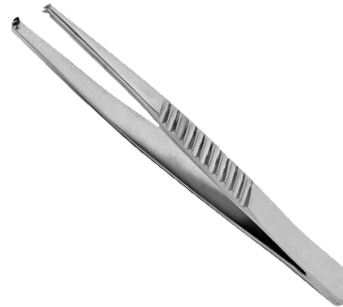

DISSECTING FORCEPS /
PINCES À DISSECTION

TAYLOR
11.0056 13 cm 1:2
11.0057 15 cm 1:2



DISSECTING FORCEPS /
PINCES À DISSECTION

BONNEY
11.0060 18 cm 1:2
11.0061 18 cm 2:3



DISSECTING FORCEPS /
PINCES À DISSECTION

NELSON
11.0062 15 cm 6:7
11.0063 20 cm 6:7
11.0064 23 cm 6:7



DISSECTING FORCEPS /
PINCES À DISSECTION

BROWN
Toothed / Dentée
11.0065 15 cm
11.0066 20 cm
11.0067 23 cm



DISSECTING FORCEPS /
PINCES À DISSECTION

LANE
11.0068 14,5 cm 1:2
11.0069 20 cm 1:2



DISSECTING FORCEPS /
PINCES À DISSECTION

RUSSIAN
11.0070 15 cm 2:3
11.0071 20 cm 2:3
11.0072 25 cm 2:3



DISSECTING FORCEPS /
PINCES À DISSECTION

MAYO-RUSSIAN
11.0073 23 cm



ATRAUMATIC FORCEPS

PINCES ATRAUMATIQUE



ATRAUMATIC FORCEPS /
PINCES ATRAUMATIQUE
WANGENSTEEN
11.0075 23 cm



ATRAUMATIC FORCEPS /
PINCES ATRAUMATIQUE
SINGLEY (TUTTLE)
11.0076 15 cm
11.0077 18 cm
11.0078 23 cm



ATRAUMATIC FORCEPS /
PINCES ATRAUMATIQUE
STILLE-BARRAYA
11.0079 18 cm
11.0080 20 cm
11.0081 25 cm



ATRAUMATIC FORCEPS /
PINCES ATRAUMATIQUE
DEBAKEY
11.0082 15 cm / 1,5 mm
11.0083 20 cm / 1,5 mm
11.0084 24 cm / 1,5 mm



ATRAUMATIC FORCEPS /
PINCES ATRAUMATIQUE
DEBAKEY
11.0088 15 cm / 2 mm
11.0089 20 cm / 2 mm
11.0090 24 cm / 2 mm
11.0091 30 cm / 2 mm



ATRAUMATIC FORCEPS /
PINCES ATRAUMATIQUE
DEBAKEY
11.0095 15 cm / 2 mm
11.0096 20 cm / 2 mm
11.0097 24 cm / 2 mm
11.0098 30 cm / 2 mm



ATRAUMATIC FORCEPS /
PINCES ATRAUMATIQUE
DEBAKEY
11.0099 15 cm / 2,7 mm
11.0100 20 cm / 2,7 mm
11.0101 24 cm / 2,7 mm
11.0102 30 cm / 2,7 mm



ATRAUMATIC FORCEPS /
PINCES ATRAUMATIQUE
DEBAKEY
11.0103 15 cm / 3,5 mm
11.0104 20 cm / 3,5 mm



ATRAUMATIC FORCEPS /
PINCES ATRAUMATIQUE
DEBAKEY
11.0105 24 cm / 3,5 mm
11.0106 30 cm / 3,5 mm



ATRAUMATIC FORCEPS /
PINCES ATRAUMATIQUE
COOLEY
11.0107 15 cm / 2 mm
11.0108 20 cm / 2 mm
11.0109 24 cm / 2 mm



THUMB AND TISSUE FORCEPS

PINCES À DISSECTION

THUMB AND TISSUE FORCEPS / PINCES A DISSECTION

2:3	3:4	4:5
11.2080 13 cm	11.2090 13 cm	11.2100 13 cm
11.2081 14,5 cm	11.2091 14,5 cm	11.2101 14,5 cm
11.2082 16 cm	11.2092 16 cm	11.2102 16 cm
11.2083 18 cm		
11.2084 20 cm		
11.2085 25 cm		

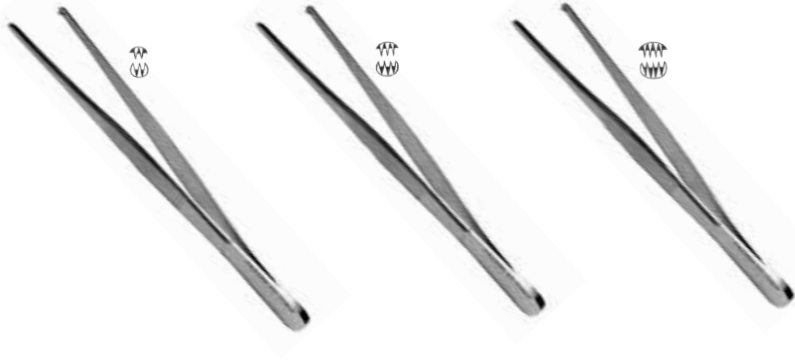

THUMB AND TISSUE FORCEPS / PINCES A DISSECTION

11.2140 12,5 cm
11.2141 15,5 cm
11.2142 12,5 cm 1:2
11.2143 15,5 cm 1:2
11.2144 15,5 cm 1:2

SPLINTER FORCEPS

PINCES A ECHARDE



SPLINTER FORCEPS / PINCES A ECHARDE

11.2150 9 cm
11.2151 11,5 cm



SPLINTER FORCEPS / PINCES A ECHARDE

FEILCHENFELD
11.2152 7,5 cm
11.2153 11,5 cm



SPLINTER FORCEPS / PINCES A ECHARDE

HUNTER
Straight/ Droite
11.2154 10,5 cm



SPLINTER FORCEPS / PINCES A ECHARDE

HUNTER
Curved / Courbe
11.2155 10,5 cm



SPLINTER FORCEPS / PINCES A ECHARDE

PEET
11.2156 11,5 cm



SPLINTER FORCEPS / PINCES A ECHARDE

STIEGLITZ
Straight/ Droite
11.2157 13,5 cm
Curved / Courbe
11.2158 13,5 cm



HEMOSTATIC FORCEPS | PINCES HÉMOSTATIQUES



HEMOSTATIC FORCEPS /
PINCES HÉMOSTATIQUES

HARTMANN
Straight / Droite
11.2160 10 cm
Curved / Courbe
11.2161 10 cm



HEMOSTATIC FORCEPS /
PINCES HÉMOSTATIQUES

HARTMANN
Straight / Droite
11.2162 10 cm 1:2
Curved / Courbe
11.2163 10 cm 1:2



HEMOSTATIC FORCEPS /
PINCES HÉMOSTATIQUES

HALSTED-MOSQUITO
Straight / Droite Curved / Courbe
11.2170 12,5 cm 11.2174 12,5 cm
11.2171 14 cm 11.2175 14 cm
11.2172 18 cm 11.2176 18 cm
11.2173 21 cm 11.2177 21 cm



HEMOSTATIC FORCEPS /
PINCES HÉMOSTATIQUES

HALSTED-MOSQUITO 1:2
Straight / Droite Curved / Courbe
11.2178 12,5 cm 11.2182 12,5 cm
11.2179 14 cm 11.2183 14 cm
11.2180 18 cm 11.2184 18 cm
11.2181 21 cm 11.2185 21 cm



HEMOSTATIC FORCEPS /
PINCES HÉMOSTATIQUES

ROCHESTER-PEAN
Straight / Droite Curved / Courbe
11.2190 13 cm 11.2200 13 cm
11.2191 14 cm 11.2201 14 cm
11.2192 16 cm 11.2202 16 cm
11.2193 18 cm 11.2203 18 cm
11.2194 20 cm 11.2204 20 cm
11.2195 22 cm 11.2205 22 cm
11.2196 24 cm 11.2206 24 cm
11.2197 26 cm 11.2207 26 cm
11.2198 30 cm 11.2208 30 cm



HEMOSTATIC FORCEPS /
PINCES HÉMOSTATIQUES

ROCHESTER-OGHSNER 1:2
Straight / Droite Curved / Courbe
11.2210 13 cm 11.2220 13 cm
11.2211 14 cm 11.2221 14 cm
11.2212 16 cm 11.2222 16 cm
11.2213 18 cm 11.2223 18 cm
11.2214 20 cm 11.2224 20 cm
11.2215 22 cm 11.2225 22 cm
11.2216 24 cm 11.2226 24 cm
11.2217 26 cm 11.2227 26 cm
11.2218 30 cm 11.2228 30 cm



HEMOSTATIC FORCEPS /
PINCES HÉMOSTATIQUES

PEAN
Straight / Droite Curved / Courbe
11.2230 14 cm 11.2231 14 cm



HEMOSTATIC FORCEPS /
PINCES HÉMOSTATIQUES

PEAN
Straight / Droite
11.2232 14 cm
11.2233 16 cm



HEMOSTATIC FORCEPS /
PINCES HÉMOSTATIQUES

KELLY
Straight / Droite Curved / Courbe
11.2240 14 cm 11.2241 14 cm



HEMOSTATIC FORCEPS /
PINCES HÉMOSTATIQUES

KELLY-RANKIN
Straight / Droite Curved / Courbe
11.2242 16 cm 11.2243 16 cm



HEMOSTATIC FORCEPS /
PINCES HEMOSTATIQUES

CRILE
Straight / Droite Curved / Courbe
11.2250 14 cm 11.2251 14 cm



HEMOSTATIC FORCEPS /
PINCES HEMOSTATIQUES

CRILE 1:2
Straight / Droite Curved / Courbe
11.2252 14 cm 11.2253 14 cm



HEMOSTATIC FORCEPS /
PINCES HEMOSTATIQUES

CRILE-RANKIN
Straight / Droite Curved / Courbe
11.2254 16 cm 11.2255 16 cm



HEMOSTATIC FORCEPS /
PINCES HEMOSTATIQUES

CRILE-RANKIN 1:2
Straight / Droite Curved / Courbe
11.2256 16 cm 11.2257 16 cm



HEMOSTATIC FORCEPS /
PINCES HEMOSTATIQUES

SPENCER-WELLS
Straight / Droite Curved / Courbe
11.2260 13 cm 11.2264 13 cm
11.2261 15 cm 11.2265 15 cm
11.2262 18 cm 11.2266 18 cm
11.2263 20 cm 11.2267 20 cm



HEMOSTATIC FORCEPS /
PINCES HEMOSTATIQUES

KOCHER 1:2
Straight / Droite Curved / Courbe
11.2270 14 cm 11.2271 14 cm



HEMOSTATIC FORCEPS /
PINCES HEMOSTATIQUES

LERICHE
Straight / Droite Curved / Courbe
11.2280 15 cm 11.2281 15 cm

LERICHE 1:2
Straight / Droite Curved / Courbe
11.2282 15 cm 11.2283 15 cm



HEMOSTATIC FORCEPS /
PINCES HEMOSTATIQUES

OMBREDANNE
11.2290 12,5 cm



HEMOSTATIC FORCEPS /
PINCES HEMOSTATIQUES

CHAPUT
11.2291 13 cm



HEMOSTATIC FORCEPS /
PINCES HEMOSTATIQUES

BENGOLEA
Straight / Droite Curved / Courbe
11.2300 20 cm 11.2310 20 cm
11.2301 26 cm 11.2311 26 cm



HEMOSTATIC FORCEPS /
PINCES HEMOSTATIQUES

BENGOLEA 1:2
Straight / Droite Curved / Courbe
11.2320 20 cm 11.2330 20 cm
11.2321 26 cm 11.2331 26 cm



HEMOSTATIC FORCEPS /
PINCES HEMOSTATIQUES

COLLIN
11.2340 16 cm



HEMOSTATIC FORCEPS /
PINCES HEMOSTATIQUES

COLLIN
11.2341 14 cm



HEMOSTATIC FORCEPS /
PINCES HEMOSTATIQUES

FERGUSSON
Angiotribes / Pincers-clamps à pression
Straight / Droite Curved / Courbe
11.2350 16 cm 11.2352 16 cm
11.2351 20 cm 11.2353 20 cm



HEMOSTATIC FORCEPS /
PINCES HEMOSTATIQUES

STILLE
Hemostatic, gall duct and kidney pedicle/
Hémostatiques, pédicule, rénal et voies biliaires
11.2360 23 cm



HEMOSTATIC FORCEPS /
PINCES HEMOSTATIQUES

MIXTER-O'SHAUGHNESSY
11.2366 15 cm
11.2367 19 cm



HEMOSTATIC FORCEPS /
PINCES HEMOSTATIQUES

DESJARDINS
11.2364 21 cm



HEMOSTATIC FORCEPS /
PINCES HEMOSTATIQUES

DESJARDINS
11.2365 21 cm

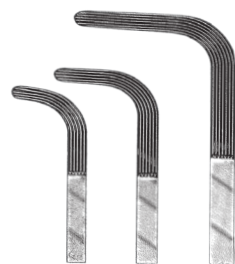

Fig. 1 Fig. 2 Fig. 3

HEMOSTATIC FORCEPS / PINCES HEMOSTATIQUES
MIXTER

11.2361 22 cm Fig. 1
11.2362 25 cm Fig. 2
11.2363 28 cm Fig. 3



HEMOSTATIC FORCEPS /
PINCES HEMOSTATIQUES

BAINBRIDGE
Straight / Droite Curved / Courbe
11.2499 15,5 cm 11.2501 15,5 cm
11.2500 18 cm 11.2502 18 cm



HEMOSTATIC FORCEPS /
PINCES HEMOSTATIQUES

MARTEL
11.2503 14 cm



HEMOSTATIC FORCEPS /
PINCES HEMOSTATIQUES

WILLET
11.2504 19 cm



HEMOSTATIC FORCEPS /
PINCES HEMOSTATIQUES

PRATT
11.2505 15 cm



HEMOSTATIC FORCEPS /
PINCES HEMOSTATIQUES

DEBAKEY
11.2506 25 cm
Small jaws / Petite pointe
11.2507 25 cm
Large jaws / Grande pointe



HEMOSTATIC FORCEPS /
PINCES HEMOSTATIQUES

MAYO
11.2508 23 cm



HEMOSTATIC FORCEPS /
PINCES HEMOSTATIQUES

STILLE
11.2509 23 cm



HEMOSTATIC FORCEPS /
PINCES HEMOSTATIQUES

HERRICK
11.2510 23 cm

HYSTERECTOMY FORCEPS

PINCES A HYSTERECTOMIE



HYSTERECTOMY FORCEPS /
PINCES A HYSTERECTOMIE

WERTHEIM
Curved / Courbe
11.2370 25 cm



HYSTERECTOMY FORCEPS /
PINCES A HYSTERECTOMIE

WERTHEIM 1:2
Curved / Courbe
11.2371 22 cm
11.2372 23 cm



HYSTERECTOMY FORCEPS /
PINCES A HYSTERECTOMIE

HEANEY
Curved / Courbe
11.2373 20 cm 1:1



HYSTERECTOMY FORCEPS /
PINCES A HYSTERECTOMIE

HEANEY
Curved / Courbe
11.2374 20 cm 1:2

PERITONEUM FORCEPS | PINCES A PERITONEUH



PERITONEUM FORCEPS /
PINCES A PERITOINE

FAURE 1:2
Half curved / Mi-courbe
11.2375 20 cm



PERITONEUM FORCEPS /
PINCES A PERITOINE

FAURE 1:2
Curved / Courbe
11.2376 20 cm

TOWEL FORCEPS | PINCES A CHAMPS



TOWEL FORCEPS /
PINCES A CHAMPS

JONES
11.2380 9 cm



TOWEL FORCEPS /
PINCES A CHAMPS

BACKHAUS
11.2390 9 cm
11.2391 11 cm
11.2392 13 cm
11.2393 15 cm



TOWEL FORCEPS /
PINCES A CHAMPS

ROEDER
11.2381 13 cm



TOWEL FORCEPS /
PINCES A CHAMPS

DOYEN
11.2382 18 cm

TUBING CLAMP | PINCES POUR TUBES



TUBING CLAMP /
PINCES POUR TUBES

11.2400 16 cm
11.2401 18 cm



TUBING CLAMP /
PINCES POUR TUBES

11.2402 15 cm
11.2403 18 cm
11.2404 20 cm



SPONGE HOLDING FORCEPS

PINCES PORTE-EPONGES



SPONGE HOLDING FORCEPS /
PINCES PORTE-EPONGES

FOERSTER SERRATED / DENTEE

Straight / Droite	Curved / Courbe
11.2410 18 cm	11.2420 18 cm
11.2411 20 cm	11.2421 20 cm
11.2412 25 cm	11.2422 25 cm



SPONGE HOLDING FORCEPS /
PINCES PORTE-EPONGES

FOERSTER SMOOTH / LISSE

Straight / Droite	Curved / Courbe
11.2430 18 cm	11.2440 18 cm
11.2431 25 cm	11.2441 25 cm



SPONGE HOLDING FORCEPS /
PINCES PORTE-EPONGES

FOERSTER SERRATED

Straight / Droite	Curved / Courbe
11.2450 25 cm	11.2451 25 cm



SPONGE HOLDING FORCEPS /
PINCES PORTE-EPONGES

RAMPLEY

11.2460 25 cm

DRESSING FORCEPS

PINCES A POLYPES



DRESSING FORCEPS /
PINCES A POLYPES

BRYANT

11.2461 13 cm



DRESSING FORCEPS /
PINCES A POLYPES

LISTER (Sinus)

11.2462 13 cm
11.2463 16 cm
11.2464 18 cm



DRESSING FORCEPS /
PINCES A POLYPES

TERRIER 1:2

11.9692 8,5 cm



DRESSING FORCEPS /
PINCES A POLYPES

GROSS-MAIER

Straight / Droite	Curved / Courbe
11.2465 20 cm	11.2467 20 cm
11.2466 25 cm	11.2468 25 cm



DRESSING FORCEPS /
PINCES A POLYPES

COLLIN

11.2469 25 cm



DRESSING FORCEPS /
PINCES A POLYPES

BOZEMAN

Straight / Droite	Curved / Courbe
11.2470 26 cm	11.2471 26 cm



DRESSING FORCEPS /
PINCES A POLYPES
BOZEMAN-DOUGLAS
11.2472 26 cm



DRESSING FORCEPS /
PINCES A POLYPES
CHERON
11.2473 25 cm

RETRACTORS | ECARTEURS



RETRACTORS / ECARTEURS
FARABEU (Pair)
11.3000 12 cm
11.3001 15 cm



RETRACTORS / ECARTEURS
ROUX (Pair)
11.3002 14 cm



RETRACTORS / ECARTEURS
US ARMY (PARKER-LANGENBECK)
11.3003 21 cm (Pair)



RETRACTORS / ECARTEURS
RICHARDSON-EASTMAN
11.3004 (Pair)



RETRACTORS / ECARTEURS
RICHARDSON
11.3005 28x20 mm
11.3006 36x28 mm
11.3007 44x38 mm



RETRACTORS / ECARTEURS
RICHARDSON GRIP
11.3008 20x25 mm
11.3009 25x31 mm
11.3010 38x38 mm
11.3011 19x51 mm
11.3012 41x64 mm



RETRACTORS / ECARTEURS
KELLY
11.3013 26 cm 65x50 mm



RETRACTORS / ECARTEURS
KELLY GRIP
11.3014 38x51 mm
11.3015 51x64 mm
11.3016 64x76 mm
11.3017 70x82 mm



RETRACTORS / ECARTEURS

DEAVER

- 11.3020 19x180 mm
- 11.3021 22x215 mm
- 11.3022 25x230 mm
- 11.3023 25x300 mm
- 11.3024 25x330 mm
- 11.3025 25x360 mm
- 11.3026 38x300 mm
- 11.3027 50x300 mm
- 11.3028 75x300 mm



RETRACTORS / ECARTEURS

DEAVER GRIP

- 11.3029 25x310 mm
- 11.3030 38x310 mm
- 11.3031 50x310 mm



RETRACTORS / ECARTEURS

HARRINGTON

- 11.3032 25x230 mm
- 11.3033 40x320 mm
- 11.3034 62x320 mm



RETRACTORS / ECARTEURS

VOLKMANN

- Sharp / Pointu 21,5 cm
- 11.3040 / 11.3041 / 11.3042
- / 11.3043 / 11.3044

VOLKMANN

- Blunt / Mousse 21,5 cm
- 11.3045 / 11.3046 / 11.3047
- / 11.3048 / 11.3049

Sharp / Pointu



- 11.3040
- 11.3041
- 11.3042
- 11.3043
- 11.3044

Blunt / Mousse



- 11.3045
- 11.3046
- 11.3047
- 11.3048
- 11.3049



RETRACTORS / ECARTEURS

DESMARRES 16 cm

- 11.3050 12 mm
- 11.3051 14 mm
- 11.3052 16 mm
- 11.3053 18 mm



RETRACTORS / ECARTEURS

CUSHING 20 cm

- 11.3060 8 mm
- 11.3061 10 mm
- 11.3062 12 mm
- 11.3063 14 mm
- 11.3064 16 mm
- 11.3065 18 mm





RETRACTORS / ECARTEURS
 SENIN 7x8,5 mm
 Sharp / Pointu Blunt / Mousse
 11.3070 17 cm 11.3071 17 cm



RETRACTORS / ECARTEURS
 LANGENBECK 21 cm
 11.3072 35x7 mm
 11.3073 35x10 mm
 11.3074 35x15 mm
 11.3075 60x20 mm



RETRACTORS / ECARTEURS
 DOYEN 90 mm wide / large
 11.3080 25 cm



RETRACTORS / ECARTEURS
 KELLY 27 cm
 11.3081 160x38 mm
 11.3082 160x57 mm



RETRACTORS / ECARTEURS
 CRILE
 11.3157 11,5 cm
 LUER
 11.3158 12 cm



HOUSE 16x7mm / 22x9 mm
 11.3159 15 cm
 SENN-GREEN 15 cm
 Short / Court Long / Longue
 11.3160 11.3161



RETRACTORS / ECARTEURS
 CUSHING
 11.3162 21 cm 10x11 mm

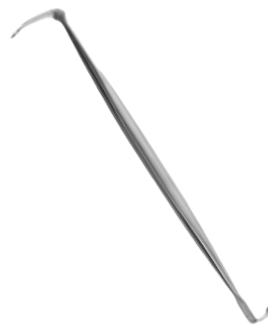

RETRACTORS / ECARTEURS
 RAGNELL
 11.3163 14 cm 8x4mm / 15x6 mm



RETRACTORS / ECARTEURS
 LANGENBECK-MINI 16 cm
 11.3164 10x6 mm
 11.3165 17x5 mm
 11.3166 20x5 mm
 11.3167 22x5 mm



RETRACTORS / ECARTEURS
 BERGMANN
 11.3122 14 cm



RETRACTORS / ECARTEURS
 GILLES
 11.3123 Small/Petit 18 cm
 11.3124 large/Grand 18 cm



RETRACTORS / ECARTEURS
 COLLIN
 11.3171 16 cm



RETRACTORS / ECARTEURS
 MATHIEU
 11.3175



RETRACTORS / ECARTEURS
 COLLIN-HARTMANN
 11.3176 16,5 cm



RETRACTORS / ECARTEURS
 ISRAEL
 11.3189 25 cm 40x40mm
 11.3190 25 cm 45x45mm
 11.3191 25 cm 50x60mm
 11.3192 25 cm 70x70mm



RETRACTORS / ECARTEURS
 LAHEY
 11.3193 19 cm 28x6mm

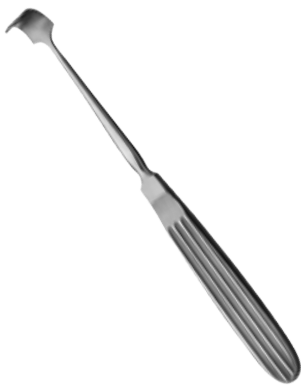

RETRACTORS / ECARTEURS
 LITTLE
 11.3194 20 cm



RETRACTORS / ECARTEURS
 KOCHER
 11.3195 25x6mm
 11.3196 35x8mm
 11.3197 35x11mm
 11.3198 35x15mm
 11.3199 40x11mm
 11.3200 55x11mm
 11.3201 70x14mm
 11.3202 80x12mm
 11.3203 80x16mm



RETRACTORS / ECARTEURS
 KOCHER
 11.3204 40x18mm
 11.3205 60x20mm
 11.3206 60x25mm
 11.3207 75x30mm
 11.3208 75x40mm



RETRACTORS / ECARTEURS
 MIDDELDORPF
 11.3218 16x17mm 22cm
 11.3219 20x22mm 22cm
 11.3220 26x30mm 22cm



RETRACTORS / ECARTEURS
 MIDDELDORPF
 11.3221 45x45mm 26cm
 11.3222 45x50mm 26cm
 11.3223 55x70mm 26cm



RETRACTORS / ECARTEURS
 MIDDELDORPF
 11.3224 20x22mm 23cm
 11.3225 26x30mm 23cm

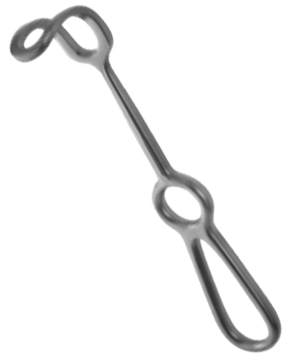

RETRACTORS / ECARTEURS
 GREEN
 11.3226 22 cm



RETRACTORS / ECARTEURS
 11.3227 35x40mm 24cm
 11.3228 45x40mm 24cm
 11.3229 45x50mm 24cm
 11.3230 45x60mm 24cm
 11.3231 55x75mm 24cm
 11.3232 65x80mm 24cm



RETRACTORS / ECARTEURS
 MIKULICZ
 11.3242 90x50mm 24 cm



RETRACTORS / ECARTEURS
 MIKULICZ
 11.3243 95x35mm 24 cm



RETRACTORS / ECARTEURS
 BECKMANN
 11.3319 30x30mm 31 cm



RETRACTORS / ECARTEURS
 ADSON-BABY
 11.3321 16 cm
 ADSON
 11.3323 32 cm



RETRACTORS / ECARTEURS
 DARLING
 11.3334 18 cm



RETRACTORS / ECARTEURS
 DARLING
 11.3335 18 cm



RETRACTORS / ECARTEURS
GELPI-MINI
11.3336 10 cm



RETRACTORS / ECARTEURS
GELPI-BABY
11.3337 14 cm



RETRACTORS / ECARTEURS
GELPI
11.3338 18 cm



RETRACTORS / ECARTEURS
GELPI
11.3339 18 cm



RETRACTORS / ECARTEURS
RIGBY
11.3342 18 cm 60x20 mm



RETRACTORS / ECARTEURS
RIGBY
11.3343 18 cm 35x20 mm



RETRACTORS / ECARTEURS
WEITLANER 12x12mm 35 mm
wide/large
SHARP / POINTU
11.3090 11,5 cm
BLUNT / MOUSSE
11.3091 11,5 cm



RETRACTORS / ECARTEURS
WEITLANER 16x18 mm
65/80mm wide/large
SHARP / POINTU
11.3092 14 cm
11.3093 16 cm
11.3094 20 cm
BLUNT / MOUSSE
11.3095 14 cm
11.3096 16 cm
11.3097 20 cm



RETRACTORS / ECARTEURS
ADSON
SHARP / POINTU
11.3100 19 cm
BLUNT / MOUSSE
11.3101 19 cm



RETRACTORS / ECARTEURS
ADSON 80mm wide / large
SHARP / POINTU
11.3102 26,5 cm
BLUNT / MOUSSE
11.3103 26,5 cm



RETRACTORS / ECARTEURS
COLLIN-BABY
 11.3350 18 cm
 Interchangeable blades
 Lames interchangeables
 18x40 mm / 27x40 mm



RETRACTORS / ECARTEURS
COLLIN
 11.3351 38x60 mm 22 cm



RETRACTORS / ECARTEURS
COLLIN
 11.3352 22 cm 60x38 mm
COLLIN
 11.3353 22 cm 60x80 mm



RETRACTORS / ECARTEURS
RICARD
 11.3358 60x80 / 55x70 mm



RETRACTORS / ECARTEURS
RICARD
 11.3359 72x85 / 80x90 mm

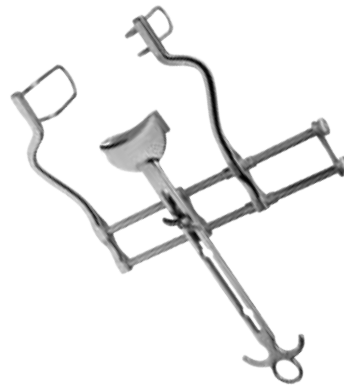

RETRACTORS / ECARTEURS
BALFOUR
 11.3110 18 cm
 180mm wide / large
 central blade / lame centrale
 45x80mm
 lateral blades / lames laterales
 35-63mm



RETRACTORS / ECARTEURS
BALFOUR
 11.3111 20 cm
 200mm wide / large
 central blade / lame centrale
 100x70 mm
 lateral blades / lames laterales
 35-100 mm



RETRACTORS / ECARTEURS
BALFOUR-BABY
 11.3112 95 mm



RETRACTORS / ECARTEURS
GOSSET
 11.3120
 140 mm wide / large
 lateral blades / lames laterales
 35-63 mm



RETRACTORS / ECARTEURS
GOSSET
 11.3121
 160 mm wide / large
 lateral blades / lames laterales
 35-63 mm



NEEDLE HOLDER | PORTE-AIGUILLES



NEEDLE HOLDER /
PORTE-AIGUILLES
CRILE WOOD
11.4000 15cm
11.4001 18cm
11.4002 20cm



NEEDLE HOLDER /
PORTE-AIGUILLES
MAYO HEGAR
11.4003 14cm
11.4004 16cm
11.4005 18cm
11.4006 20cm
11.4007 24cm
11.4008 26cm
11.4009 30cm



NEEDLE HOLDER /
PORTE-AIGUILLES
MAYO HEGAR
11.4010 16cm
11.4011 18cm
11.4012 20cm



NEEDLE HOLDER /
PORTE-AIGUILLES
DERF
11.4013 12cm
11.4014 12,5cm



NEEDLE HOLDER /
PORTE-AIGUILLES
OLSEN-HEGAR
11.4020 14 cm
11.4021 18 cm
GILLES
11.4022 16 cm



NEEDLE HOLDER /
PORTE-AIGUILLES
MATHIEU
11.4023 14 cm
11.4024 17 cm
11.4025 20 cm
11.4026 24 cm
MATHIEU (NARROW)
11.4027 14 cm
11.4028 17 cm



NEEDLE HOLDER /
PORTE-AIGUILLES
FINOCCHIETTO
11.4029 20 cm
11.4030 27 cm
CASTROVIEJO
Straight / Droite Curved / Courbe
11.4031 14 cm 11.4032 14 cm



NEEDLE HOLDER /
PORTE-AIGUILLES
METZENBAUM
11.3690 18 cm
ADSON
11.3691 18 cm



NEEDLE HOLDER /
PORTE-AIGUILLES
KILNER
Serrated/Dentee
11.4017 13 cm
Smooth/lisse
11.4018 13 cm



NEEDLE HOLDER /
PORTE-AIGUILLES
MICRO
Straight / Droite Curved / Courbe
11.4019 14 cm 11.4034 14 cm
11.4033 18 cm 11.4035 18 cm
MICRO
Straight / Droite Curved / Courbe
11.4036 14 cm 11.4038 14 cm
11.4037 18 cm 11.4039 18 cm



LIGATURE NEEDLES

AIGUILLES A LIGATURES



cm 15



cm 19-23

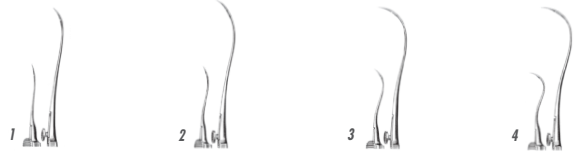

LIGATURE NEEDLES / AIGUILLES A LIGATURES

REVERDIN

Fig.1

11.4060 15 cm
11.4064 19 cm
11.4065 21 cm
11.4066 23 cm

Fig.2

11.4061 15 cm
11.4067 19 cm
11.4068 21 cm
11.4069 23 cm

Fig.3

11.4062 15 cm
11.4070 19 cm
11.4071 21 cm
11.4072 23 cm

Fig.4

11.4063 15 cm
11.4073 19 cm
11.4074 21 cm
11.4075 23 cm



LIGATURE NEEDLES / AIGUILLES A LIGATURES

DESCHAMPS sharp/pointue

Left/Gauche

11.4040 21cm

11.4041 24cm

11.4042 27cm

Right/Droit

11.4043 21cm

11.4044 24cm

11.4045 27cm



LIGATURE NEEDLES / AIGUILLES A LIGATURES

DESCHAMPS blunt/mousse

Left/Gauche

11.4046 21cm

11.4047 24cm

11.4048 27cm

Right/Droit

11.4049 21cm

11.4050 24cm

11.4051 27cm

PROBES, DIRECTORS

STYLETS, SONDES

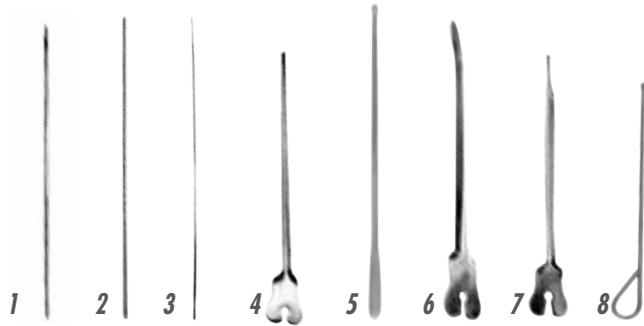

PROBES, DIRECTORS / STYLETS, SONDES

Fig.1

Ø 2mm with eye/
avec oeil

11.4080 11,5cm

11.4081 13cm

11.4082 14,5cm

11.4083 16cm

11.4084 18cm

11.4085 20cm

11.4086 25cm

Fig.2

Ø 1mm

11.4090 11,5cm

11.4091 13cm

11.4092 14,5cm

11.4093 16cm

11.4094 18cm

11.4095 20cm

11.4096 25cm

Fig.3

Ø 2mm

11.4100 11,5cm

11.4101 13cm

11.4102 14,5cm

11.4103 16cm

11.4104 18cm

11.4105 20cm

11.4106 25cm

Fig.4

11.4120 11,5cm

11.4121 13cm

11.4122 14,5cm

11.4123 16cm

11.4124 18cm

11.4125 20cm

11.4126 25cm

Fig.5

11.4110 14,5cm

Fig.6

Doyen

11.4130 14cm

Fig.7

11.4140 14,5cm

Fig.8

Stacke

11.4150 10,5cm

TROCARS

TROCARTS



TROCARS / TROCARTS

UNIVERSAL

11.4160

Set of 4 pcs. / Jeu de 4 pcs.

Ø 6 4½ 3 1½



TROCARS / TROCARTS

STANDARD

11.4161 3 mm

11.4162 3,5 mm

11.4163 4 mm

11.4164 4,5 mm

11.4165 5 mm

11.4166 5,5 mm

11.4167 6 mm



TROCARS / TROCARTS

STANDARD

11.4168 3 mm

11.4169 3,5 mm

11.4170 4 mm

11.4171 4,5 mm

11.4172 5 mm

11.4173 5,5 mm

11.4174 6 mm



TROCARS / TROCARTS

PIERCE

11.4175 3 mm

11.4176 4 mm

11.4177 5 mm

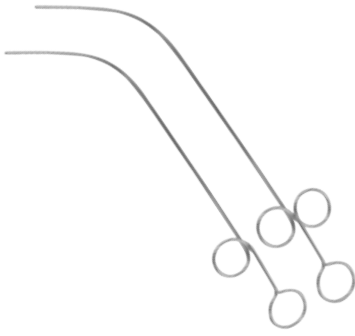

TROCARS / TROCARTS

PELTERSON
11.4178 23 cm
11.4179 28 cm

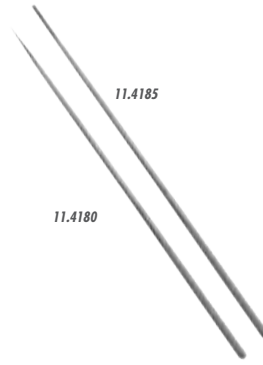

TROCARS / TROCARTS

FARRELL
11.4180 12 cm 11.4185 12 cm
11.4181 14 cm 11.4186 14 cm
11.4182 16 cm 11.4187 16 cm
11.4183 18 cm 11.4188 18 cm
11.4184 23 cm 11.4189 23 cm



TROCARS / TROCARTS

MARTIN
11.4190 12 cm 11.4194 12 cm
11.4191 14 cm 11.4195 14 cm
11.4192 16 cm 11.4196 16 cm
11.4193 18 cm 11.4197 18 cm

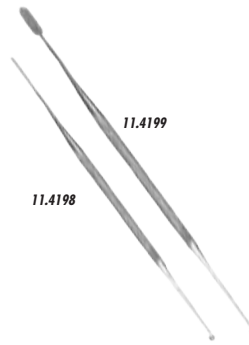

TROCARS / TROCARTS

UCKERMANN
11.4198
JOBSON-HORNE
11.4199 14,5 cm
11.4200 18 cm

TENACULUM FORCEPS | PINCES POUR ABAISSEMENT DU COL DE L'UTERUS



TENACULUM FORCEPS /
PINCES POUR ABAISSEMENT DU
COL DE L'UTERUS

SCHROEDER-POZZI
11.5000 25 cm



TENACULUM FORCEPS /
PINCES POUR ABAISSEMENT DU
COL DE L'UTERUS

BRAUN
11.5001 25 cm

VULSELLUM FORCEPS | PINCES POUR ABAISSEMENT DU COL DE L'UTERUS



VULSELLUM FORCEPS /
PINCES POUR ABAISSEMENT DU
COL DE L'UTERUS

DUPLAY
11.5002 28 cm



VULSELLUM FORCEPS /
PINCES POUR ABAISSEMENT DU
COL DE L'UTERUS

SCHROEDER
Straight / Droite Curved / Courbe
11.5003 24 cm 11.5004 24 cm

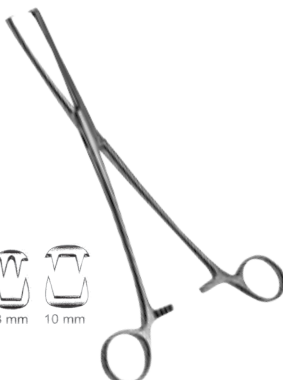

VULSELLUM FORCEPS /
PINCES POUR ABAISSEMENT DU
COL DE L'UTERUS

MUSEUX 24cm
Straight / Droite Curved / Courbe
11.5005 6 mm 11.5008 6 mm
11.5006 8 mm 11.5009 8 mm
11.5007 10 mm 11.5008 10 mm



VULSELLUM FORCEPS /
PINCES POUR ABAISSEMENT DU
COL DE L'UTERUS

TEALE
Curved / Courbe
11.5011 23 cm

JACOBS
Straight / Droite Curved / Courbe
11.5012 21 cm 11.5013 21 cm



UTERINE POLYPUS FORCEPS

PINCES A POLYPES UTERINS



UTERINE POLYPUS FORCEPS /
PINCES A POLYPES UTERINS

DOYEN
11.5020 20 cm



UTERINE POLYPUS FORCEPS /
PINCES A POLYPES UTERINS

KELLY
11.5021 32 cm

UTERINE ELEVATING FORCEPS

PINCES HYSTEROLABES

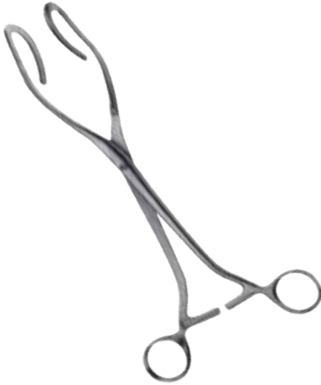

UTERINE ELEVATING FORCEPS /
PINCES HYSTEROLABES

DARTIGUES
11.5022 27 cm



UTERINE ELEVATING FORCEPS /
PINCES HYSTEROLABES

COLLIN
11.5023 25 cm

AMNIOTOME, UTERINE DEPRESSORS

AMNIOTOME, DEPRESSEURUS UTERINS



11.5030

11.5031

11.5032

11.5033

11.5035

11.5037

11.5038

AMNIOTOME, UTERINE DEPRESSORS, UTERINE
SOUNDS /
AMNIOTOME, DEPRESSEURUS UTERINS,
HYSTEROMETRES

BEACHAM
11.5030 26 cm

BRAUN
11.5031 28 cm

SIMS
11.5032 26 cm

SIMS
11.5033 32 cm

Rigid/Rigide
11.5034 32 cm
Malleable/Malleable

MARTIN
11.5035 32 cm

Rigid/Rigide
11.5036 32 cm
Malleable/Malleable

COLLIN
11.5037 28 cm

VALLEIX
11.5038 30 cm

UTERINE BIOPSY ASPIRATING CURETTES

CURETTES ASPIRANTES A BIOPSIE DE L'UTERUS

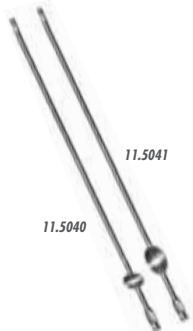

UTERINE BIOPSY ASPIRATING CURETTES /
CURETTES ASPIRANTES A BIOPSIE DE
L'UTERUS

RANDALL 24cm
11.5040 4 mm

NOVAK 24cm
11.5041 1 mm
11.5042 2 mm
11.5043 3 mm
11.5044 4 mm



UTERINE BIOPSY ASPIRATING CURETTES /
CURETTES ASPIRANTES A BIOPSIE DE
L'UTERUS

KEVORKIAN 30 cm
11.5045 1,2 mm
11.5046 4 mm

KEVORKIAN 30 cm
With Basket/Avec panier
11.5047 4 mm

BIOPSY SPECIMEN FORCEPS

PINCES A BIOPSIE



11.5050

11.5051

BIOPSY SPECIMEN FORCEPS /
PINCES A BIOPSIE

FAURE
11.5050 21 cm

SCHUBERT
11.5051 21 cm
11.5052 28 cm

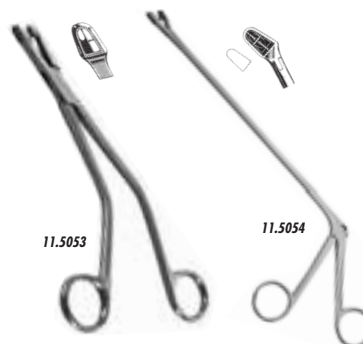

11.5053

11.5054

BIOPSY SPECIMEN FORCEPS /
PINCES A BIOPSIE

SCHUBERT
11.5053 21 cm

ALEXANDER
Blade length/longueur lame 20 cm
11.5054 28 cm



UTERINE CURETTES | CURETTES UTERINES

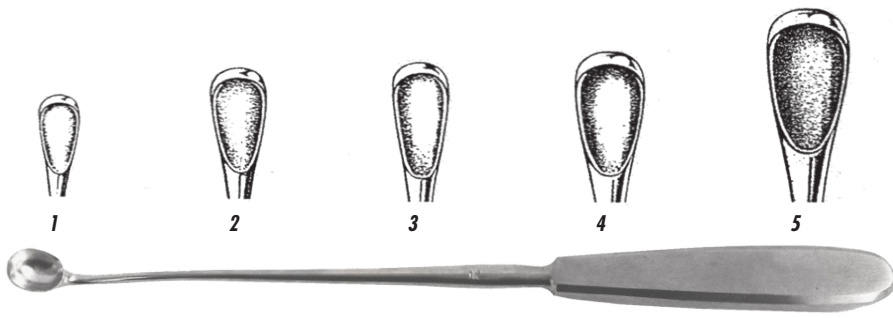

UTERINE CURETTES / CURETTES UTERINES

GOURDET

- Fig.1 11.5060 28cm 5mm
- Fig.2 11.5061 28cm 7mm
- Fig.3 11.5062 28cm 8mm
- Fig.4 11.5063 28cm 10mm
- Fig.5 11.5064 28cm 12mm

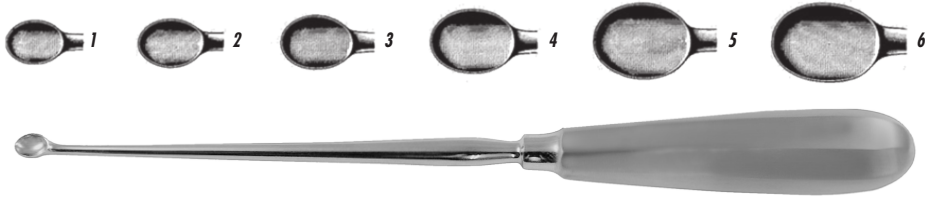

UTERINE CURETTES / CURETTES UTERINES

SIMON

- Fig.1 11.5070 25cm 7mm
- Fig.2 11.5071 25cm 8mm
- Fig.3 11.5072 25cm 9mm
- Fig.4 11.5073 25cm 11mm
- Fig.5 11.5074 25cm 13mm
- Fig.6 11.5075 25cm 14mm

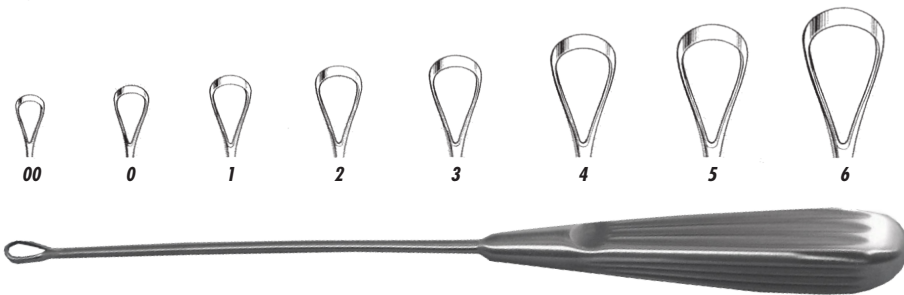

UTERINE CURETTES / CURETTES UTERINES

SIMS

- 28 cm
- Sharp/Tranchante
- Fig.00 11.5090 5mm
- Fig.0 11.5091 6mm
- Fig.1 11.5092 7mm
- Fig.2 11.5093 8mm
- Fig.3 11.5094 9mm
- Fig.4 11.5095 11mm
- Fig.5 11.5096 12mm
- Fig.6 11.5097 14mm

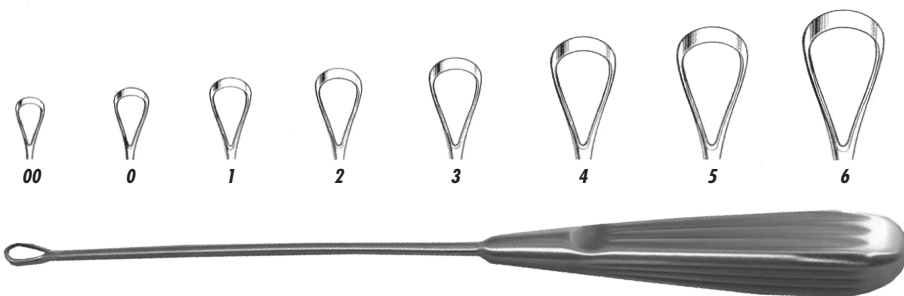

UTERINE CURETTES / CURETTES UTERINES

SIMS

- 28 cm
- Blunt/Mousse
- Fig.00 11.5100 5mm
- Fig.0 11.5101 6mm
- Fig.1 11.5102 7mm
- Fig.2 11.5103 8mm
- Fig.3 11.5104 9mm
- Fig.4 11.5105 11mm
- Fig.5 11.5106 12mm
- Fig.6 11.5107 14mm



UTERINE CURETTES / CURETTES UTERINES

BLAKE

- 11.5080 27 cm
- Sharp/Blunt - Tranchant/Mousse



VAGINAL SPECULUM | SPECULUM VAGINAL



VAGINAL SPECULUM /
SPECULUM VAGINAL

KRISTELLER

Fig.1 11.5110 70x27mm
Fig.2 11.5111 80x30mm
Fig.3 11.5112 90x36mm



VAGINAL SPECULUM /
SPECULUM VAGINAL

SIMS

Fig.1 11.5120 60x25/30mm
Fig.2 11.5121 70x30/35mm
Fig.3 11.5122 80x35/40mm
11.5123 Complete set/Jeu complet

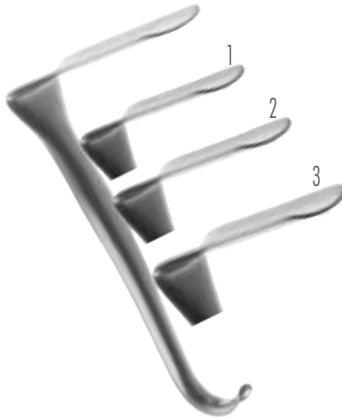

VAGINAL SPECULUM /
SPECULUM VAGINAL

JACKSON

Fig. 1 11.5130 75x38mm
Fig. 2 11.5131 90x38mm
Fig. 3 11.5132 100x38mm

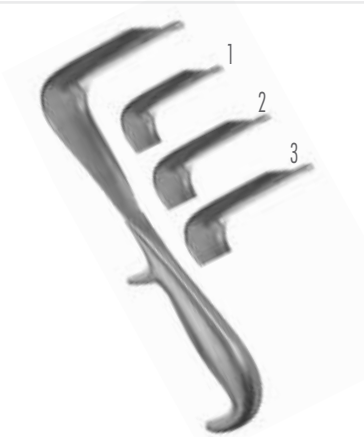

VAGINAL SPECULUM /
SPECULUM VAGINAL

DOYEN

Fig.1 11.5140 55x35mm
Fig.2 11.5141 85x35mm
Fig.3 11.5142 115x35mm
Fig.1 11.5143 55x45mm
Fig.2 11.5144 85x45mm
Fig.3 11.5145 115x45mm
Fig.4 11.5146 160x45mm
Fig.1 11.5147 55x60mm
Fig.2 11.5148 85x60mm
Fig.3 11.5149 115x60mm
Fig.4 11.5150 160x60mm



VAGINAL SPECULUM /
SPECULUM VAGINAL

AUVARD 23cm

With detachable weight
Avec poids amovible

11.5151 65x38 -28 mm
1,530 kg = 3 lbs.
11.5152R 75x42 -40 mm
11.5153R 105x43 -40 mm
1,470 kg = 3 lbs.



VAGINAL SPECULUM /
SPECULUM VAGINAL

CUSCO

Lateral screw/Vis latérale

Fig. 1 08.681 75x32mm
Fig. 2 08.682 85x35mm
Fig. 3 08.683 100x35mm
Fig. 4 08.684 Virgo

CUSCO

Central screw/Vis centrale

Fig. 1 08.685 75x32mm
Fig. 2 08.686 85x36mm
Fig. 3 08.687 95x37mm
Fig. 4 08.688 Virgo



VAGINAL SPECULUM /
SPECULUM VAGINAL

COLLIN

08.689/V Virgo
08.689 85x30mm
08.690 100x35mm
08.691 110x40mm



VAGINAL SPECULUM /
SPECULUM VAGINAL

GRAVE

08.692 75x20mm
08.693 95x35mm
08.694 115x35mm



VAGINAL SPECULUM /
SPECULUM VAGINAL

PEDERSON

08.695 75x13mm
08.696 100x22mm
08.697 120x25mm



VAGINAL SPECULUM /
SPECULUM VAGINAL

KOGAN

11.5160 24 cm



UTERINE DILATORS | DILATATEURS UTERINS

UTERINE DILATORS/DILATATEURS UTERINS



11.5170	1 mm	11.5182	13 mm	11.5194	25 mm	11.5205	6,5 mm
11.5171	2 mm	11.5183	14 mm	11.5195	26 mm	11.5206	7,5 mm
11.5172	3 mm	11.5184	15 mm	11.5196	27 mm	11.5207	8,5 mm
11.5173	4 mm	11.5185	16 mm	11.5197	28 mm	11.5208	9,5 mm
11.5174	5 mm	11.5186	17 mm	11.5198	29 mm	11.5209	10,5 mm
11.5175	6 mm	11.5187	18 mm	11.5199	30 mm	11.5210	11,5 mm
11.5176	7 mm	11.5188	19 mm	11.5200	1,5 mm	11.5211	12,5 mm
11.5177	8 mm	11.5189	20 mm	11.5201	2,5 mm	11.5212	13,5 mm
11.5178	9 mm	11.5190	21 mm	11.5202	3,5 mm	11.5213	14,5 mm
11.5179	10 mm	11.5191	22 mm	11.5203	4,5 mm	11.5214	15,5 mm
11.5180	11 mm	11.5192	23 mm	11.5204	5,5 mm	11.5215	16,5 mm
11.5181	12 mm	11.5193	24 mm				



UTERINE DILATORS/ DILATATEURS UTERINS

HEGAR
11.5235 4-17mm
14 pieces/pièces



UTERINE DILATORS/ DILATATEURS UTERINS

HEGAR
11.5230 4-17mm
14 pieces/pièces
11.5231 1-26mm
26 pieces/pièces



UTERINE DILATORS/DILATATEURS UTERINS

11.5240	1-2 mm	11.5249	19-20 mm
11.5241	3-4 mm	11.5250	21-22 mm
11.5242	5-6 mm	11.5251	23-24 mm
11.5243	7-8 mm	11.5252	25-26 mm
11.5244	9-10 mm		
11.5245	11-12 mm	SET/JEU	
11.5246	13-14 mm	11.5255	8 Pcs
11.5247	15-16 mm	11.5256	13 Pcs
11.5248	17-18 mm	11.5258	8 Pcs



UTERINE DILATORS/ DILATATEURS UTERINS

HANK
11.5260 4,5-5 mm
11.5261 4,5-6 mm
11.5262 4,5-7 mm
11.5263 4,5-8 mm
11.5264 4,5-9 mm
11.5265 4,5-10 mm
SET/JEU
11.5270 6 Pcs

OBSTETRICAL FORCEPS | FORCEPS OBSTETRICALE



11.5280



11.5281



11.5282

OBSTETRICAL FORCEPS / FORCEPS OBSTETRICALE

WRIGLEY
11.5280 23 cm

SIMPSON
11.5281 30 cm

SIMPSON-BRAUN
11.5282 33 cm
11.5283 36 cm



11.5284



11.5286



11.5287

OBSTETRICAL FORCEPS / FORCEPS OBSTETRICALE

NAEGELE
11.5284 36 cm
11.5285 40 cm

KIELLAND
11.5286 41 cm

TARNIER
11.5287 40 cm



PLACENTA AND OVUM FORCEPS

FORCEPS POUR PLACENTA ET OVUM



PLACENTA AND OVUM FORCEPS /
FORCEPS POUR PLACENTA ET OVUM

WINTER

Straight/Droite

Fig. 1 11.5290 28 cm small/petit

Fig. 2 11.5291 28 cm medium/moyen

Fig. 3 11.5292 28 cm large/large

Curved/Courbe

Fig. 1 11.5293 28 cm small/petit

Fig. 2 11.5294 28 cm medium/moyen

Fig. 3 11.5295 28 cm large/large

PERFORATOR

PERFORATEUR



PERFORATOR / PERFORATEUR

SMELLIE

11.5300 25cm

OBSTETRICAL HOOK

CROCHET OBSTETRICALE



OBSTETRICAL HOOK /
CROCHET OBSTETRICALE

SMELLIE

11.5301 33 cm



OBSTETRICAL HOOK /
CROCHET OBSTETRICALE

BRAUN

11.5302 30 cm

PELVIMETRES, UMBILICAL CORD CLAMP

PELVIMETRES, CLAMP POUR CORDON OMBILICAL



PELVIMETRES, UMBILICAL CORD
CLAMP /
PELVIMETRES, CLAMP POUR
CORDON OMBILICAL

MARTIN

Pelvimetres
11.5310 34 cm



PELVIMETRES, UMBILICAL CORD CLAMP /
PELVIMETRES, CLAMP POUR CORDON
OMBILICAL

COLLYER

Pelvimetres
11.5311 30 cm

COLLIN

Umbilical cord clamp / Clamp pour cordon
ombilical
11.5320 9 cm

BIOPSY SPECIMEN FORCEPS

PINCES A BIOPSIE

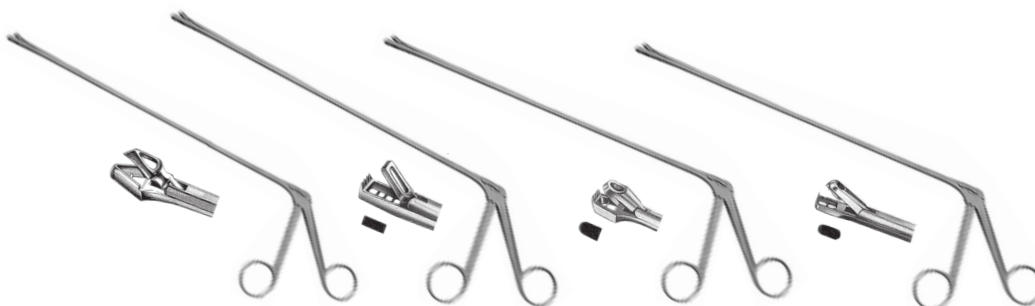

BIOPSY SPECIMEN FORCEPS /
PINCES A BIOPSIE

SCHUMACHER

11.5330 24 cm

11.5331 24 cm

KEVORKIAN

11.5335 24,5 cm

3x9,7 mm

WITTNER

Straight/Droite

11.5340 23 cm 4x8 mm

Curved/Courbe

11.5341 23 cm 4x8 mm

TISCHLER-MORGAN

11.5345 3x7 mm



EAR SPECULUM | SPECULUMS AURICULAIRES



EAR SPECULA /
SPECULUMS AURICULAIRES

HARTMANN
11.6000 3mm
11.6001 4,5mm
11.6002 5,5mm
11.6003 6,5mm
11.6004 7,5mm
11.6005 Set 4 Pcs



EAR SPECULA /
SPECULUMS AURICULAIRES

GRUBER
11.6010 4,5mm
11.6011 5,5mm
11.6012 6,5mm
11.6013 7,5mm
11.6015 Set 4 Pcs

LOOPS, HOOKLETS | ANSES, CROCHETS



LOOPS, HOOKLETS /
ANSES, CROCHETS

BILLEAU
Fig. 1 11.6030
Fig. 2 11.6031
Fig. 3 11.6032

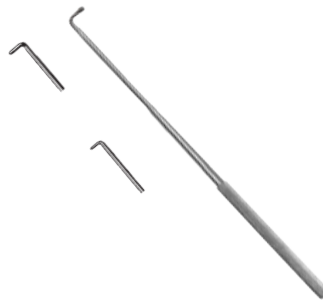

LOOPS, HOOKLETS /
ANSES, CROCHETS

DAY
Fig. 1 11.6040
Fig. 2 11.6041

EAR SYRINGE | SERINGUE AURICULAIRE



EAR SYRINGE /
SERINGUE AURICULAIRE

REINER
11.6020 50 ml
11.6021 75 ml
11.6022 100 ml
11.6023 150 ml

DRESSING FORCEPS | PINCES



DRESSING FORCEPS / PINCES

LUCAE
11.6050 14 cm
LUCAE
11.6051 14 cm



DRESSING FORCEPS / PINCES

WILDE (TROELTSCH)
Serrated/Dentee Smooth/Lisse
11.6060 12 cm 11.6061 12 cm

MICRO EAR FORCEPS | PINCES AURICULAIRES MICRO

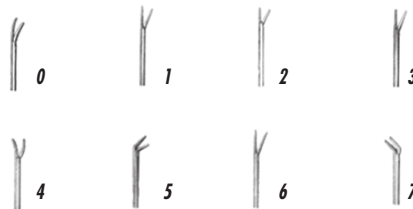

MICRO EAR FORCEPS /
PINCES AURICULAIRES MICRO

MICRO EAR FORCEPS
0- 11.6124 6mm
1- 11.6121 7mm
2- 11.6120 4mm
3- 11.6127 3,5mm
4- 11.6123 6mm
5- 11.6125 4mm
6- 11.6122 4mm
7- 11.6126 4mm

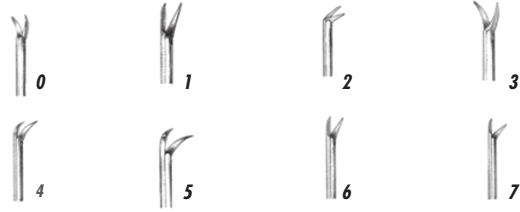

MICRO EAR FORCEPS / PINCES AURICULAIRES MICRO		
0- 11.6133	5,5mm	BELLUCCI micro standard
1- 11.6135	7mm	SHEA
2- 11.6132	5,5mm	BELLUCCI micro standard
3- 11.6134	5,5mm	BELLUCCI micro standard
4- 11.6137	7mm	SHEA
5- 11.6136	7mm	SHEA
6- 11.6131	5,5mm	BELLUCCI micro standard
7- 11.6130	4mm	BELLUCCI micro mini

EAR FORCEPS | PINCES AURICULAIRES



EAR FORCEPS /
PINCES AURICULAIRES

TILLEY
11.6070 14 cm
LITTAUER
11.6071 12 cm



EAR FORCEPS /
PINCES AURICULAIRES

HARTMANN
11.6072 12 cm
HARTMANN
11.6073 14 cm



EAR FORCEPS /
PINCES AURICULAIRES

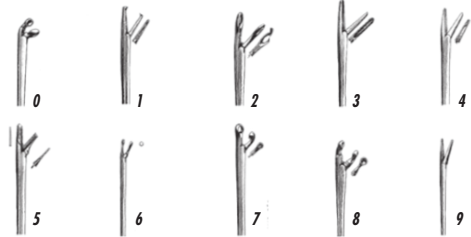

HARTMANN		HARTMANN	
0- 11.6110	8,5 cm Ø 3mm	5- 11.6112	8,5cm
1- 11.6100	8,5 cm	HARTMANN-WULLSTEIN	
	11.6101 14 cm	6- 11.6091	8,5cm
STRUEMPEL		9- 11.6090	8,5cm
2- 11.6111	8,5 cm	HARTMANN-HOFFMANN	
HARTMANN		7- 11.6113	8,5 cm Ø 2mm
3- 11.6102	8,5 cm	HARTMANN	
4- 11.6092	8,5 cm	8- 11.6103	8,5 cm Ø 2mm
	11.6093 14 cm		11.6104 8,5 cm Ø 2,5mm
	11.6094 16 cm		11.6105 8,5 cm Ø 3mm

FOREIGN BODY LEVERS | PINCES POUR CORPS ETRANGERS



FOREIGN BODY LEVERS /
PINCES POUR CORPS ETRANGERS

QUIRE
11.6080 10cm



FOREIGN BODY LEVERS /
PINCES POUR CORPS ETRANGERS

BUCK
11.6081 11 cm

TUNING FORKS | DIAPASONS



TUNING FORKS / DIAPASONS

FRENCH
11.6140 C² 16
11.6141 C¹ 32
HARTMANN
11.6142 C64
11.6143 C128
11.6144 C¹ 256
Aluminium / Aluminium
11.6145 C128
11.6146 C¹ 256

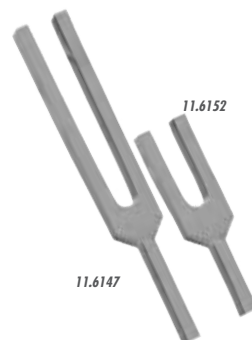

TUNING FORKS / DIAPASONS

HARTMANN
11.6147 C128
11.6148 C¹ 256
11.6149 C² 512
11.6150 C³ 1024
11.6151 C⁴ 2048
11.6152 C⁵ 4096
Aluminium / Aluminium
11.6153 C¹ 256
11.6154 C² 512
11.6155 C³ 1024
11.6156 C 2048



TUNING FORKS / DIAPASONS

LUCAE
11.6157 C128
11.6158 C1 256
11.6159 C2 512
11.6160 C3 1024
11.6161 C4 2048
11.6162 C5 4096



TUNING FORKS / DIAPASONS

11.6163 A1 440
RYDEL-SEIFFER
11.6164 C64 / C128



TUNING FORKS / DIAPASONS

LUCAE
11.6165 C128
HARTMANN
11.6166 C128



TUNING FORKS / DIAPASONS

SET OF 5 TUNING FORKS
JEU DE 5 DIAPASONS
11.6170 (C128,256,512,1024,2048)
SET OF 5 ALUMINIUM TUNING FORKS
JEU DE 5 DIAPASONS EN ALUMINIUM
11.6171 (C128,256,512,1024,2048)
SET OF 8 TUNING FORKS
JEU DE 8 DIAPASONS
11.6172 (C32,64,128,256,512,1024,
2048,4096)

NASAL SPECULUM | SPECULUMS NASAUX

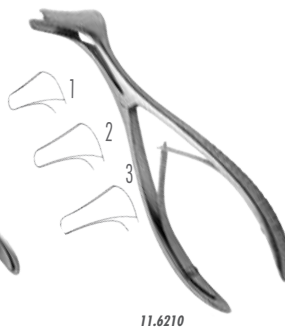
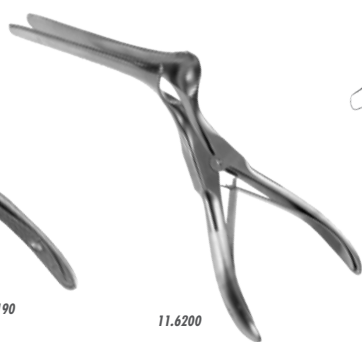
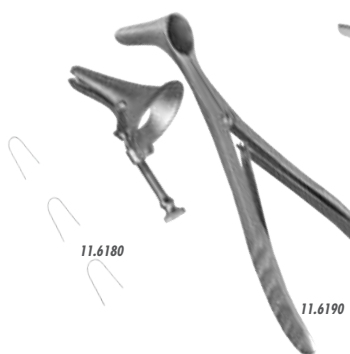

NASAL SPECULA / SPECULUMS NASAUX

VOLTOLINI
Fig. 1 11.6180
Fig. 2 11.6181
Fig. 3 11.6182
VIENNA
11.6190
KILLIAN 13cm
11.6200 35 mm
11.6201 50 mm
11.6202 75 mm
11.6203 90 mm
HARTMANN-HALLE
Fig. 1 11.6210 15 cm
Fig. 2 11.6211 15 cm
Fig. 3 11.6212 15 cm

NASAL FORCEPS | PINCES NASAUX

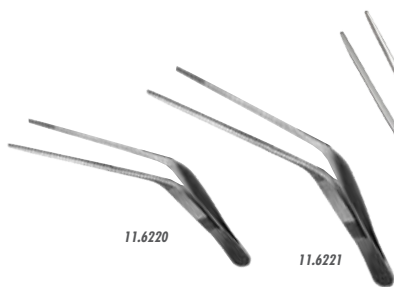

NASAL FORCEPS / PINCES NASAUX

TROELTSCH
11.6220 15 cm
11.6221 18 cm
11.6222 20 cm
HARTMANN
11.6231 20 cm
JANSEN
11.6222 20 cm
HARTMANN
11.6230 16 cm

TONGUE DEPRESSORS | ABAISSE-LANGUE



TONGUE DEPRESSORS /
ABAISSE-LANGUE
08.821 14 cm
08.822 19 cm
BRUENINGS
11.6240 19 cm



TONGUE DEPRESSORS /
ABAISSE-LANGUE
HARTMANN
11.6241 15cm
WIEDER
11.6242 14cm
11.6243 15cm



LARYNGEAL MIRROR | MIROIR LARYNGE

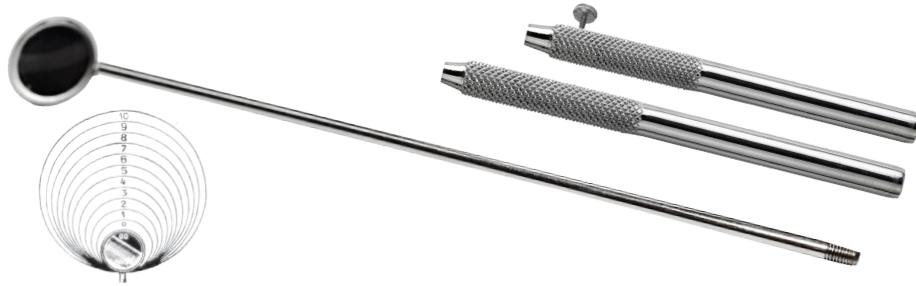

LARYNGEAL MIRROR / MIROIR LARYNGE

11.6250 8mm 00	11.6256 20mm 5
11.6251 10mm 0	11.6257 22mm 6
11.6252 12mm 1	11.6258 24mm 7
11.6253 14mm 2	11.6259 26mm 8
11.6254 16mm 3	11.6260 28mm 9
11.6255 18mm 4	11.6261 30mm 10

HANDLE FOR LARYNGEAL MIRROR /
MANCHE POUR MIROIR LARYNGE

11.6265
11.6270

TONGUE HOLDING FORCEPS | PINCES TIRE-LANGUE



TONGUE HOLDING FORCEPS /
PINCES TIRE-LANGUE

COLLIN
11.6280 16cm
11.6281 18cm



TONGUE HOLDING FORCEPS /
PINCES TIRE-LANGUE

YOUNG
11.6285 16cm

MOUTH GAG | OUVRE-BOUCHE



MOUTH GAG / OUVRE-BOUCHE

DOYEN-JANSEN (MOLT)
11.6290 12cm
DOYEN-JANSEN (MOLT)
11.6291 14cm



MOUTH GAG / OUVRE-BOUCHE

MAUNDER
11.6292 (wood/bois)



MOUTH GAG / OUVRE-BOUCHE

ROSER-KOENIG
11.6293 16cm
11.6294 19cm



MOUTH GAG / OUVRE-BOUCHE

HEISTER
11.6295 13cm

TRACHEOSTOMY | TRACHEOSTOMIE

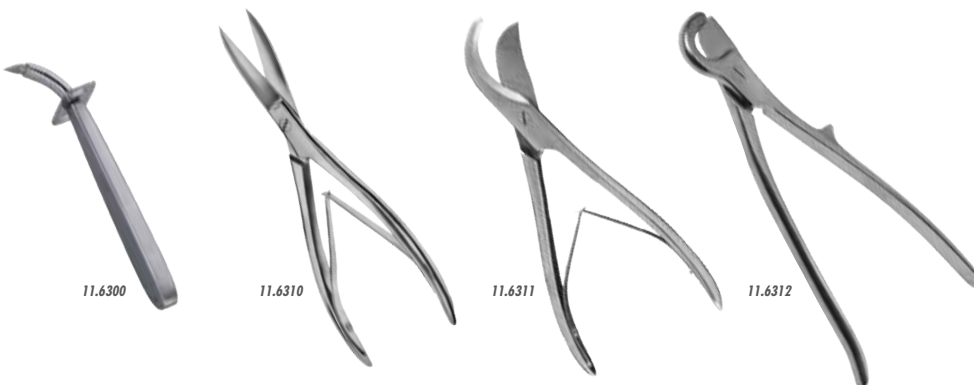

TRACHEOSTOMY / TRACHEOSTOMIE

UCKERMANN Tracheostome
11.6300 13cm ø 7,5mm
11.6301 13cm ø 9mm

Rib shears / Costotomes
11.6310 23cm
11.6311 22cm

STILLE
11.6312 21cm

11.6300

11.6310

11.6311

11.6312



TONSIL INSTRUMENTS | INSTRUMENTS POUR AMYGDALES



TONSIL NEEDLE / AIGUILLE
POUR AMYGDALES

DUPUY-WEISS (Right/Droite)
11.6320 22 cm

DUPUY-WEISS (Left/Gauche)
11.6321 22 cm



TONSIL NEEDLE / AIGUILLE
POUR AMYGDALES

CARPENTER
11.6322 25 cm

CARPENTER
11.6323 24 cm



TONSIL FORCEPS / PINCES
POUR AMYGDALES

NEGUS

Curved/Courbe
11.6324 19 cm
Half Curved/Mi-Courbe
11.6325 19 cm



TONSIL FORCEPS / PINCES
POUR AMYGDALES

COLVER

11.6326 19 cm
Curved/Courbe
11.6327 19 cm



TONSIL FORCEPS / PINCES
POUR AMYGDALES

WHITE

11.6328 18 cm
11.6329 23 cm



TONSIL FORCEPS / PINCES
POUR AMYGDALES

SLUDER-BALLENGER

11.6330 with 3 blades/avec 3 lames

JURASZ

Fig 1 11.6331 23cm
Fig 2 11.6332 23cm
Fig 3 11.6333 23cm
Fig 4 11.6334 23cm

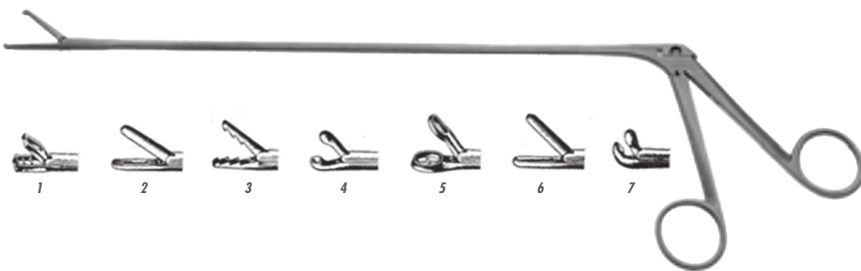

TONSIL FORCEPS / PINCES POUR AMYGDALES

1-11.6335 30cm	4-11.6347 30cm	7-11.6359 30cm
11.6336 40cm	11.6348 40cm	11.6360 40cm
11.6337 50cm	11.6349 50cm	11.6361 50cm
11.6338 60cm	11.6350 60cm	11.6362 60cm
2-11.6339 30cm	5-11.6351 30cm	
11.6340 40cm	11.6352 40cm	
11.6341 50cm	11.6353 50cm	
11.6342 60cm	11.6354 60cm	
3-11.6343 30cm	6-11.6355 30cm	
11.6344 40cm	11.6356 40cm	
11.6345 50cm	11.6357 50cm	
11.6346 60cm	11.6358 60cm	

GALL STONE FORCEPS | PINCES POUR VOIES BILIAIRES

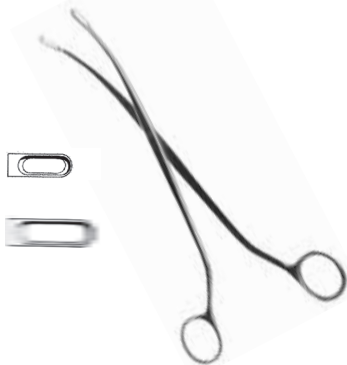

GALL STONE FORCEPS /
PINCES POUR VOIES BILIAIRES

DESJARDINS

11.6380 23 cm
11.6381 23 cm



GALL STONE FORCEPS /
PINCES POUR VOIES BILIAIRES

BLAKE

Straight/Droite
11.6382
Curved/Courbe
11.6383



GALL STONE FORCEPS /
PINCES POUR VOIES BILIAIRES

MAYO BLAKE
11.6384 20 cm



GALL STONE FORCEPS /
PINCES POUR VOIES BILIAIRES

MAYO BLAKE
11.6385 20 cm



GALL STONE FORCEPS /
PINCES POUR VOIES BILIAIRES

MIXTER
11.6386 22 cm



GALL STONE PROBE /
SONDE POUR VOIES BILIAIRES

MOORE
Gall stone scoop/cuillère pour voies biliaires
11.6387

OCHSNER
Gall stone probe/Sonde pour voies biliaires
11.6388

MAYO
Gall stone probe/Sonde pour voies biliaires
11.6390 32 cm

URETER CLAMPS | PINCES-CLAMPS A URETRE



URETER CLAMPS /
PINCES-CLAMPS A URETRE

LURZ
11.6391 21 cm



URETER CLAMPS /
PINCES-CLAMPS A URETRE

LURZ
11.6392 21 cm

KIDNEY STONE FORCEPS | PINCES A CALCULS RENAUX



KIDNEY STONE FORCEPS /
PINCES A CALCULS RENAUX

RANDALL
Fig. 1 11.6393 23 cm
Fig. 2 11.6394 22 cm
Fig. 3 11.6395 22 cm
Fig. 4 11.6396 22 cm
Fig. 5 11.6397 19 cm
Fig. 6 11.6398 19 cm

INTESTINE AND STOMACH INSTRUMENTS | INSTRUMENTS POUR INTESTIN ET ESTOMAC



INTESTINE AND STOMAC /
INTESTIN ET ESTOMAC

ALLIS-BABY 4:5
11.6400 14 cm

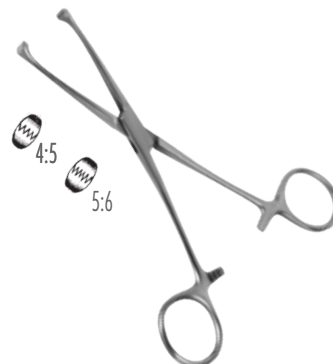

INTESTINE AND STOMAC /
INTESTIN ET ESTOMAC

ALLIS
11.6401 15 cm 4:5
11.6402 15 cm 5:6
11.6403 19 cm 5:6
11.6404 22 cm 5:6
11.6405 24 cm 5:6



INTESTINE AND STOMAC /
INTESTIN ET ESTOMAC

BABCOCK
11.6406 16 cm
11.6407 18 cm
11.6408 20 cm
11.6409 24 cm



INTESTINE AND STOMAC /
INTESTIN ET ESTOMAC

DOYEN BABY
Straight/Droite Curved/Courbe
11.6410 18 cm 11.6411 18 cm

DOYEN
Straight/Droite Curved/Courbe
11.6412 21 cm 11.6414 21 cm
11.6413 23 cm 11.6415 23 cm



INTESTINE AND STOMAC /
INTESTIN ET ESTOMAC

DUVAL
11.6420 18cm x 13mm
11.6421 20cm x 13mm
11.6422 20cm x 25mm
11.6423 23cm x 25mm



INTESTINE AND STOMAC /
INTESTIN ET ESTOMAC

KOCHER
Straight/Droite Curved/Courbe
11.6430 22 cm 11.6440 22 cm
11.6431 25 cm 11.6441 25 cm
11.6432 28 cm 11.6442 28 cm

STOMACH CLAMPS | PINCES-CLAMPS STOMACALES



STOMACH CLAMPS /
PINCES-CLAMPS STOMACALES

LANE
11.6450 30cm



STOMACH CLAMPS /
PINCES-CLAMPS STOMACALES

LANE
11.6451 30cm

DILATING BOUGIES, METAL CATHETERS | BOUGIES DILATATRICES, SONDES METALLIQUES

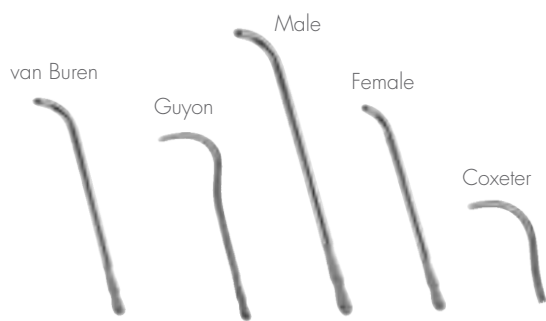

DILATING BOUGIES, METAL CATHETERS / BOUGIES DILATATRICES, SONDES METALLIQUES

Ch./FG.	van Buren	Ch./FG.	van Buren	Ch./FG.	Guyon	Male	Female	Coxeter
8	11.6460	26	11.6469	8	11.6478	11.6490	11.6499	11.6508
10	11.6461	28	11.6470	10	11.6479	11.6491	11.6500	11.6509
12	11.6462	30	11.6471	12	11.6480	11.6492	11.6501	11.6510
14	11.6463	32	11.6472	14	11.6481	11.6493	11.6502	11.6511
16	11.6464	34	11.6473	16	11.6482	11.6494	11.6503	11.6512
18	11.6465	36	11.6474	18	11.6483	11.6495	11.6504	11.6513
20	11.6466	38	11.6475	20	11.6484	11.6496	11.6505	11.6514
22	11.6467	40	11.6476	22	11.6485	11.6497	11.6506	11.6515
24	11.6468			24	11.6486	11.6498	11.6507	11.6516

van Buren Complete set / Jeu complete
11.6477 Dim. 8-36

Intermediate sizes / Dimensiones intermediaries
Ch./FG. 9 11.6487 Ch./FG. 11 11.6488
Ch./FG. 39 11.6489

RECTAL SPECULUM | SPECULUMS RECTAUX



RECTAL SPECULA /
SPECULUMS RECTAUX

SIMS
11.6520 15 cm



RECTAL SPECULA /
SPECULUMS RECTAUX

PRATT
11.6521



ANOSCOPES, PROCTOSCOPES

ANOSCOPES, PROCTOSCOPES



ANOSCOPES, PROCTOSCOPES /
ANOSCOPES, PROCTOSCOPES

KELLY Ø x L
11.6522 22x50 mm
11.6523 22x100 mm
11.6524 22x140 mm
11.6525 22x200 mm

CYSTIC HOOKS

ECARTEURS RECTAUX

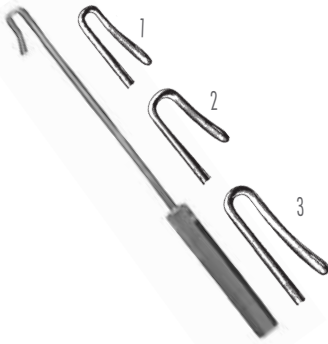

CYSTIC HOOKS /
ECARTEURS RECTAUX

PRATT
Fig. 1 11.6526
Fig. 2 11.6527
Fig. 3 11.6528

STERILIZATION INSTRUMENTS

INSTRUMENTS A STERILISATION



STERILIZATION INSTRUMENTS /
INSTRUMENTS A STERILISATION

DAVIS
11.7000 16 cm
11.7001 20 cm
11.7002 24 cm



STERILIZATION INSTRUMENTS /
INSTRUMENTS A STERILISATION

CHEATE
11.7003 27 cm



STERILIZATION INSTRUMENTS /
INSTRUMENTS A STERILISATION

ROGGE
11.7004 23 cm



STERILIZATION INSTRUMENTS /
INSTRUMENTS A STERILISATION

11.7005 20 cm
11.7006 30 cm

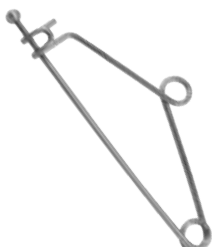

STERILIZATION INSTRUMENTS /
INSTRUMENTS A STERILISATION

MAYO
Safety pin / Epingle de surete
11.7007 14 cm



COTTON HOLDER /
PORTE-COTON

MAYO
11.7010 12 cm
11.7011 14 cm
11.7012 16 cm
11.7013 18 cm
11.7013.10 30cm



EYE MAGNET | MAGNET A CORPS ETRANGERS



EYE MAGNET /
MAGNET A CORPS ETRANGERS
11.7014

SUTURE FORCEPS | PINCES POUR AGRAFFES



SUTURE FORCEPS /
PINCES POUR AGRAFFES
MICHEL
11.7015 12 cm



SUTURE FORCEPS /
PINCES POUR AGRAFFES
MICHEL
11.7016 12 cm



SUTURE FORCEPS /
PINCES POUR AGRAFFES
MICHEL
11.7017 13 cm



SUTURE FORCEPS /
PINCES POUR AGRAFFES
COLLIN
11.7018 13 cm

ASPIRATING CANULA | CANULES D'ASPIRATION



ASPIRATING CANULA /
CANULES D'ASPIRATION
POOLE
11.7020 Ø 10 mm 30Fr.
11.7021 Ø 8 mm 23Fr.



ASPIRATING CANULA /
CANULES D'ASPIRATION
YANKAUER
05.7030 27 cm



ASPIRATING CANULA /
CANULES D'ASPIRATION
FRAZIER 19cm
Ch./F.G. 30° 75°
6 11.7041 11.7048
7 11.7042 11.7049
8 11.7043 11.7050
9 11.7044 11.7051
10 11.7045 11.7052
11 11.7046 11.7053
12 11.7047 11.7054



ASPIRATING CANULA /
CANULES D'ASPIRATION
ADSON
11.7040 21 cm / 4mm



INTUBATION FORCEPS

PINCES POUR INTUBATION



INTUBATION FORCEPS /
PINCES POUR INTUBATION

MAGILL
08.800 17 cm
08.801 20 cm
08.802 25 cm

PINARD STETHOSCOPE

STETHOSCOPE PINARD



PINARD STETHOSCOPE /
STETHOSCOPE PINARD

WOOD / BOIS
08.899



PINARD STETHOSCOPE /
STETHOSCOPE PINARD

ALUMINIUM / ALUMINIUM
08.900

PERCUSSION HAMMERS

MARTEAUX-PERCUTEURS



PERCUSSION HAMMERS /
MARTEAUX-PERCUTEURS

BUCK
08.910 18 cm



PERCUSSION HAMMERS /
MARTEAUX-PERCUTEURS

BABINSKY
08.911 22 cm



PERCUSSION HAMMERS /
MARTEAUX-PERCUTEURS

DEJERINE
08.912 20 cm



PERCUSSION HAMMERS /
MARTEAUX-PERCUTEURS

TAYLOR
Plastic handle / Manche en
plastique
08.913 19 cm
Chrome plated handle / Manche
en acier chromé
08.914 20 cm

BONE RONGEUR

GOUGE OSSEUSE



BONE RONGEUR /
GOUGE OSSEUSE

ADSON
Straight/Droite Curved/Courbe
11.8000 20cm 11.8001 20cm



BONE RONGEUR /
GOUGE OSSEUSE

RUSKIN
Straight/Droite Curved/Courbe
11.8002 18cm 11.8003 18cm



BONE RONGEUR /
GOUGE OSSEUSE
RUSKIN
11.8004 23cm
STILLE-RUSKIN
11.8005 23cm



BONE RONGEUR /
GOUGE OSSEUSE
STILLE-LUER
Straight/Droite Curved/Courbe
11.8006 22cm 11.8008 22cm
11.8007 26cm 11.8009 26cm

BONE CUTTING FORCEPS | PINCES COUPANTES A OS



BONE CUTTING FORCEPS /
PINCES COUPANTES A OS
LISTON
Straight/Droite Curved/Courbe
11.8010 14cm 11.8014 14cm
11.8011 17cm 11.8015 17cm
11.8012 19cm 11.8016 19cm
11.8013 22cm 11.8017 22cm



BONE CUTTING FORCEPS /
PINCES COUPANTES A OS
RUSKIN-HISTON
Straight/Droite Curved/Courbe
11.8018 18,5cm 11.8019 18,5cm
STILLE-HISTON
Straight/Droite Curved/Courbe
11.8020 27cm 11.8021 27cm

BONE HOLDING FORCEPS | DAVIERS PORTE-OS



BONE HOLDING FORCEPS /
DAVIERS PORTE-OS
VERBRUGGE
11.8022 17,5cm
11.8023 25cm
11.8024 26cm
11.8025 27cm



BONE HOLDING FORCEPS /
DAVIERS PORTE-OS
FARABEUFLAMBOTTE
11.8050 26cm



BONE HOLDING FORCEPS /
DAVIERS PORTE-OS
LAMBOTTE
11.8051 22cm
11.8052 27cm
11.8053 30cm

BONE CURETTES | CURETTES A OS



BONE CURETTES / CURETTES A OS
SIMON 24 cm
11.8030 Fig.1
11.8031 Fig.2
11.8032 Fig.3
11.8034 Fig.4
11.8035 Fig.5
11.8036 Fig.6

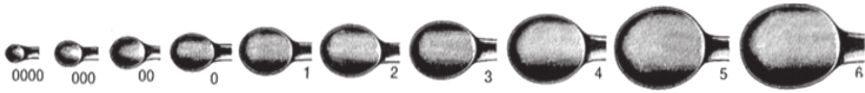

BONE CURETTES / CURETTES A OS

- VOLKMANN 17 cm
 11.8040 Fig.0000
 11.8041 Fig.000
 11.8042 Fig.00
 11.8043 Fig.0
 11.8044 Fig.1
 11.8045 Fig.2
 11.8046 Fig.3
 11.8047 Fig.4
 11.8048 Fig.5
 11.8049 Fig.6



BONE CHISEL | CISEAU A OS



BONE CHISEL / CISEAU A OS

- HIBBS 24cm
 Fig. 1 Fig. 3 Fig. 5
 11.8060 6mm 11.8070 6mm 11.8080 6mm
 11.8061 13mm 11.8071 13mm 11.8081 13mm
 11.8062 19mm 11.8072 19mm 11.8082 19mm
 11.8063 25mm 11.8073 25mm 11.8083 25mm
 11.8064 32mm 11.8074 32mm 11.8084 32mm
 Fig. 2 Fig. 4
 11.8065 6mm 11.8075 6mm
 11.8066 13mm 11.8076 13mm
 11.8067 19mm 11.8077 19mm
 11.8068 25mm 11.8078 25mm
 11.8069 32mm 11.8079 32mm



BONE CHISEL / CISEAU A OS

- STILLE 20cm
 Fig. 1 Fig. 3
 11.8085 10 mm 11.8093 10 mm
 11.8086 15 mm 11.8094 15 mm
 11.8087 20 mm 11.8095 20 mm
 11.8088 25 mm 11.8096 25 mm
 Fig. 2
 11.8089 10 mm
 11.8090 15 mm
 11.8091 20 mm
 11.8092 25 mm



BONE CHISEL / CISEAU A OS

- LAMBOTTE
 Straight 24Cm Curved 23Cm
 Droite Courbe
 11.8097 6,5mm 11.8104
 6,5mm
 11.8098 15mm 11.8105 15mm
 11.8099 20mm 11.8106 20mm
 11.8100 25mm 11.8107 25mm
 11.8101 30mm 11.8108 30mm
 11.8102 38mm 11.8109 38mm
 11.8103 44mm 11.8110 44mm

RETRACTOR FOR AMPUTATION | RETRACTEUR POUR L'AMPUTATION

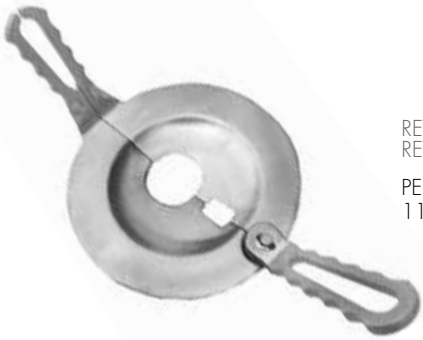

RETRACTOR FOR AMPUTATION /
RETRACTEUR POUR L'AMPUTATION

- PERCY
 11.8120

AMPUTATION SAW | SCIE POUR AMPUTATION



AMPUTATION SAW /
SCIE POUR AMPUTATION

- CHARRIERE
 11.8121 3 mm
 11.8122 5 mm
 11.8123 7 mm
 SATTERLEE
 11.8125 31 cm



AMPUTATION SAW /
SCIE POUR AMPUTATION

- CHARRIERE
 11.8124 30 cm
 LANGENBECK
 11.8126 23 cm



FINGER AND NAIL PERFORATOR | PERFORATEUR POUR DOIGTS ET ONGLES

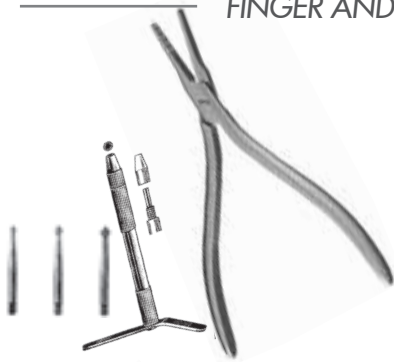

FINGER AND NAIL PERFORATOR /
PERFORATEUR POUR DOIGTS ET ONGLES
Finger and nail perforator with 3 pins
Perforateur pour doigts et ongles avec 3 broches
11.8130
Set of 3 pins / Jeu de 3 broches
11.8131
RADOLF
Nail extractor / Davier pour ongles
11.8132 13,5 cm

RING CUTTER | COUPE POUR ANNEAU



RING CUTTER /
COUPE POUR ANNEAU
11.8133 Without blade / Sans lame
11.8134 Blade only / Lame seulement

SCALPEL BLADES CARBON STEEL | LAMES DE BISTOURIS ACIER AU CARBONE

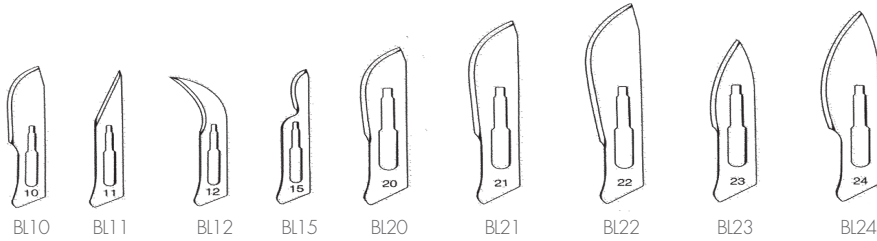

SCALPEL BLADES CARBON STEEL
In packages of 100 pieces
LAMES DE BISTOURIS ACIER AU CARBONE
En boites de 100 pieces.

SCALPEL HANDLES | MANCHES DE BISTOURI



KNIVES | COUTEAUX

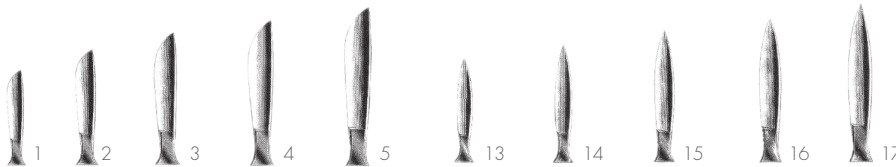

N°	CODE
1	08.129
2	08.130
3	08.131
4	08.132
5	08.133
13	08.134
14	08.135
15	08.136
16	08.137
17	08.138



N°	CODE	SIZE
N° 1 AMPUTATION	08.139	13cm
	08.140	16cm
	08.141	19cm
	08.142	22cm
	08.143	28cm
N° 2 LISTON	08.144	17cm
	08.145	20cm
	08.146	16cm
N° 3 CATLIN	08.147	19cm
	08.148	22cm
	08.149	12cm
N° 4 LANGENBECK	08.149	12cm
N° 5 LANGENBECK	08.150	10,5cm

По вопросам продаж и поддержки обращайтесь:

Алматы (7273)495-231
Ангарск (3955)60-70-56
Архангельск (8182)63-90-72
Астрахань (8512)99-46-04
Барнаул (3852)73-04-60
Белгород (4722)40-23-64
Благовещенск (4162)22-76-07
Брянск (4832)59-03-52
Владивосток (423)249-28-31
Владикавказ (8672)28-90-48
Владимир (4922)49-43-18
Волгоград (844)278-03-48
Вологда (8172)26-41-59
Воронеж (473)204-51-73
Екатеринбург (343)384-55-89
Иваново (4932)77-34-06
Ижевск (3412)26-03-58
Иркутск (395)279-98-46
Казань (843)206-01-48
Россия +7(495)268-04-70

Калининград (4012)72-03-81
Калуга (4842)92-23-67
Кемерово (3842)65-04-62
Киров (8332)68-02-04
Коломна (4966)23-41-49
Кострома (4942)77-07-48
Краснодар (861)203-40-90
Красноярск (391)204-63-61
Курск (4712)77-13-04
Липецк (4742)52-20-81
Магнитогорск (3519)55-03-13
Москва (495)268-04-70
Мурманск (8152)59-64-93
Набережные Челны (8552)20-53-41
Нижний Новгород (831)429-08-12
Новокузнецк (3843)20-46-81
Ноябрьск (3496)41-32-12
Новосибирск (383)227-86-73
Киргизия +996(312)-96-26-47

Омск (3812)21-46-40
Орел (4862)44-53-42
Оренбург (3532)37-68-04
Пенза (8412)22-31-16
Петрозаводск (8142)55-98-37
Псков (8112)59-10-37
Пермь (342)205-81-47
Ростов-на-Дону (863)308-18-15
Рязань (4912)46-61-64
Самара (846)206-03-16
Саранск (8342)22-96-24
Санкт-Петербург (812)309-46-40
Саратов (845)249-38-78
Севастополь (8692)22-31-93
Симферополь (3652)67-13-56
Смоленск (4812)29-41-54
Сочи (862)225-72-31
Ставрополь (8652)20-65-13
Сургут (3462)77-98-35
Казахстан +7(7172)727-132

Сыктывкар (8212)25-95-17
Тамбов (4752)50-40-97
Тверь (4822)63-31-35
Тольятти (8482)63-91-07
Томск (3822)98-41-53
Тула (4872)33-79-87
Тюмень (3452)66-21-18
Ульяновск (8422)24-23-59
Улан-Удэ (3012)59-97-51
Уфа (347)229-48-12
Хабаровск (4212)92-98-04
Чебоксары (8352)28-53-07
Челябинск (351)202-03-61
Череповец (8202)49-02-64
Чита (3022)38-34-83
Якутск (4112)23-90-97
Ярославль (4852)69-52-93